



STEELER®

CHEVROLET
CITROEN
DACIA
FIAT
FORD
HONDA
HYUNDAI
ISUZU
JEEP
KIA
LAND ROVER
LEXUS
MERCEDES
MITSUBISHI
NISSAN
OPEL
REANULT
SEAT
SKODA
SUBARU
TOYOTA
VOLKSWAGEN
VOLVO



**PROBABLY
THE BEST
DESIGN
IN THE WORLD**

TABLE OF CONTENTS



CHEVROLET CAPTIVA 2012-2015	5	KIA SPORTAGE 2008-2010	66
CHEVROLET TRAX 2013-	7	KIA SPORTAGE 2010-2015	67
CITROEN JUMPER 2006-2014	8	KIA SPORTAGE 2015-2018	69
CITROEN JUMPER 2014-2016	9	LAND ROVER FREELANDER II 2007-2014	71
DACIA DUSTER 2010-2014	10	LEXUS NX F-SPORT 2014-	73
DACIA DUSTER 2014-2018	11	MERCEDES SPRINTER 2006-2013-2018	74
DACIA SANDERO STEPWAY 2012-2016	12	MERCEDES V-CLASS 2014-	75
FIAT DUCATO 2006-2014	13	MERCEDES VITO 2003-2010	77
FIAT DUCATO 2014-2016-	14	MERCEDES VITO 2014-	78
FIAT FULLBACK 2015-	15	MERCEDES X-CLASS 2017-	80
FORD CONNECT 2013-2018	18	MITSUBISHI ASX 2010-2013	83
FORD COURIER 2014-2018	19	MITSUBISHI ASX 2012-2017	85
FORD KUGA 2008-2013	20	MITSUBISHI ASX 2017-	87
FORD KUGA 2012-2017	22	MITSUBISHI L200 2006-2009 / 2009-2015	89
FORD KUGA 2017-	24	MITSUBISHI L200 2015-	91
FORD RANGER 2007-2012	26	MITSUBISHI OUTLANDER 2007-2010	94
FORD RANGER 2012-2016	28	MITSUBISHI OUTLANDER 2010-2012	96
FOR RANGER 2016-	30	MITSUBISHI OUTLANDER 2012-2015	98
FORD TRANSIT 2006-2014	33	MITSUBISHI OUTLANDER 2015-	100
FORD TRANSIT 2014-	34	MITSUBISHI PAJERO 2007-2014	102
FORD TRANSIT CUSTOM 2012-2018	35	MITSUBISHI PAJERO 2014-	104
HONDA CRV 2006-2009	37	NISSAN JUKE 2010-2014	106
HONDA CRV 2012-2016	38	NISSAN NAVARA 2005-2010 / 2010-2015	107
HONDA CRV 2016-	40	NISSAN NAVARA NP300 2015-	109
HYUNDAI IX35 2010-2013-2015	41	NISSAN PATHFINDER 2005-2010 / 2010-	112
HYUNDAI SANTA-FE 2012-2018	43	NISSAN QASHQAI 2007-2010	113
HYUNDAI TUCSON 2015-	45	NISSAN QASHQAI 2010-2013	115
ISUZU D-MAX 2012-2017	47	NISSAN QASHQAI 2013-2017	117
ISUZU D-MAX 2017-	49	NISSAN QASHQAI 2017-	119
Isuzu D-MAX - AT35	52	NISSAN X-TRAIL 2007-2010 / 2010-2012-	121
JEEP GRAND CHEROKEE 2011-2014	54	NISSAN X-TRAIL 2014-2017	123
JEEP GRAND CHEROKEE 2015-	55	OPEL CROSSLAND X 2017-	125
JEEP RENEGADE 2014-	56	OPEL VIVARO 2014-	126
KIA SORENTO 2010-2012	58	REANULT KADJAR 2016-	128
KIA SORENTO 2012-2015	60	REANULT MASTER 2010-	130
KIA SORENTO 2015-2018	62	SEAT ATECA 2016-	131
KIA SOUL 2008-2013	64	SKODA KODIAQ 2016-	133
KIA SPORTAGE 2008-2010	65	SUBARU FORESTER 2008-2012	135

TABLE OF CONTENTS

SUBARU FORESTER 2013-2016	137
SUBARU FORESTER 2016-	139
SUZUKI GRAND VITARA 2006-2015	141
SUZUKI JIMNY 2005-2012	143
SUZUKI JIMNY 2012-2018	145
SUZUKI SX4 2006-2013	147
SUZUKI SX4 S-CROSS 2013-2016	148
SUZUKI SX4 S-CROSS 2016-	150
SUZUKI VITARA 2015-	152
TOYOTA HILUX 2005-2011-2015	154
Toyota Hilux - AT35	156
TOYOTA HILUX 2015-2018	158
TOYOTA HILUX 2018-	161
Toyota Hilux / Hilux Revo - AT35	164
TOYOTA LAND CRUISER 120 2003-2009	166
TOYOTA LAND CRUISER 150 2010-2013	168
TOYOTA LAND CRUISER 150 2013-2017	170
Toyota Land Cruiser 150 - AT35	172
TOYOTA LAND CRUISER 150 2017-	174
TOYOTA LAND CRUISER V8 2007-2012 / 2012-2016	176
Toyota Land Cruiser V8 / LC200 - AT35	178
TOYOTA PROACE / PROACE VERSO 2016-	180
TOYOTA RAV4 2006-2010	181
TOYOTA RAV4 2010-2013	183
TOYOTA RAV4 2013-2015	185
TOYOTA RAV4 2015-	187
VOLKSWAGEN AMAROK 2009-2016	189
VOLKSWAGEN AMAROK V6 2016-	191
VOLKSWAGEN CADDY 2010-2017	194
VOLKSWAGEN CRAFTER 2006-2017	195
VOLKSWAGEN CRAFTER 2017-	196
VOLKSWAGEN T5 2003-2010-2015	198
VOLKSWAGEN T6 2015-	200
VOLKSWAGEN TIGUAN 2007-2011-2015	202
VOLKSWAGEN TOUREG 2011-2015	204
VOLVO XC60 2014-2017	206
4x4 & pick-up accessories	208



„e”

NORMA
STANDARD
HOPMA
FRANCE

Dyrektywa 78/2009/EC określa wymagania jakie muszą spełniać bezpieczne rury montowane na samochodach poruszających się po drogach całej Europy - w tym też Polski. Jako jedyny polski producent potrafimy osiągnąć wystarczającą jakość by sprostać wymaganiom tej normy. Pamiętajmy, że w przypadku kolizji orurowanie zabezpiecza samochód i jednocześnie chroni pieszych przed urazami.

78/2009/EC directive specifies the demands that have to be met by pedestrian protection guard installed in cars in entire Europe, including Poland. As the exclusive Polish manufacturer, we can reach the sufficient quality to meet the demands posed by this standard. We need to remember that in case of collision the front guard system secures your car and protects pedestrians against injury.

Директива 78/2009/ЕС определяет требования, какие должны выполнять безопасные трубы на автомобилях, которые перемещаются по дорогам всей Европы - в том и Польши. Наша фирма является единственным польским производителем, осуществляющим требования этой директивы в области качества. Мы должны помнить, что современная установка навесного оборудования обеспечивает машину в такой же степени, как и пешеходов.

Die Richtlinie 78/2009/ EC bestimmt Anforderungen, die die auf Autos montierten sicheren Bügel innerhalb von EU erfüllen müssen. Wir sind der einzige Hersteller in Polen, der solche Qualität erreicht und diese Rechtsform bewältigen kann. Man soll immer in Erinnerung behalten, dass während einer Kollision die Bügel das Auto schützen und gleichzeitig die Fußgänger gegen Verletzungen sichern.

La directive 78/2009 / CE spécifie les exigences auxquelles doivent répondre les pare-buffles sécurisés montés sur les voitures circulant sur les routes à travers l'Europe - y compris la Pologne. En tant que seul fabricant polonais, nous pouvons atteindre une qualité suffisante pour répondre aux exigences de cette norme. Rappelez-vous qu'en cas de collision, le pare buffle protège la voiture et protège en même temps les piétons contre les blessures.

CHEVROLET CAPTIVA 2012-2015



POLISHED: CAPTIVA-R1170
BLACK: CAPTIVA-R1170-B



POLISHED: CAPTIVA-R1160-R
BLACK: CAPTIVA-R1160-R-B



POLISHED: CAPTIVA-R1176-PR-01
BLACK: CAPTIVA-R1176-PR-01-B



POLISHED: CAPTIVA-R1170-PR-02
BLACK: CAPTIVA-R1170-PR-02-B

CHEVROLET CAPTIVA

2012-2015



POLISHED: CAPTIVA-R1170-03
BLACK: CAPTIVA-R1170-03-B



POLISHED: CAPTIVA-R1170-04
BLACK: CAPTIVA-R1170-04-B



POLISHED: CAPTIVA-R1170-05
BLACK: CAPTIVA-R1170-05-B



POLISHED: CAPTIVA-R1170-06
BLACK: CAPTIVA-R1170-06-B



POLISHED: CAPTIVA-R1170-07
BLACK: CAPTIVA-R1170-07-B



POLISHED: CAPTIVA-R1170-08
BLACK: CAPTIVA-R1170-08-B

POLISHED: CAPTIVA-R1148-NR-02
BLACK: CAPTIVA-R1148-NR-02-B



CHEVROLET TRAX

2013-



POLISHED: TRAX-R1360-03
BLACK: TRAX-R1360-03-B



POLISHED: TRAX-R1360-04
BLACK: TRAX-R1360-04-B



POLISHED: TRAX-R1360-05
BLACK: TRAX-R1360-05-B



POLISHED: TRAX-R1360-08
BLACK: TRAX-R1360-08-B



POLISHED: TRAX-R1360-R
BLACK: TRAX-R1360-R-B



POLISHED: TRAX-R1376-PR-01
BLACK: TRAX-R1376-PR-01-B



POLISHED: TRAX-R1370-PR-02
BLACK: TRAX-R1370-PR-02-B

CITROEN JUMPER

2006-2014



POLISHED: JUMPER-R0070
BLACK: JUMPER-R0070-B



POLISHED: JUMPER-R0070-03
BLACK: JUMPER-R0070-03-B



POLISHED: JUMPER-R0070-06
BLACK: JUMPER-R0070-06-B



POLISHED: JUMPER-R0070-04
BLACK: JUMPER-R0070-04-B

CITROEN JUMPER

2014-2016



POLISHED: JUMPER-R0070
BLACK: JUMPER-R0070-B



POLISHED: JUMPER-R0070-03
BLACK: JUMPER-R0070-03-B



POLISHED: JUMPER-R0070-04
BLACK: JUMPER-R0070-04-B



POLISHED: JUMPER-R0070-06
BLACK: JUMPER-R0070-06-B

DACIA DUSTER

2010-2014

POLISHED: DUSTER-R1060-00
BLACK: DUSTER-R1060-00-B



POLISHED: DUSTER-R1060-03
BLACK: DUSTER-R1060-03-B



POLISHED: DUSTER-R1060-04
BLACK: DUSTER-R1060-04-B



POLISHED: DUSTER-R1076-03
BLACK: DUSTER-R1076-03-B



POLISHED: DUSTER-R1076-04
BLACK: DUSTER-R1076-04-B



POLISHED: DUSTER-R1048-NR
BLACK: DUSTER-R1048-NR-B



POLISHED: DUSTER-R1060-R
BLACK: DUSTER-R1060-R-B

DACIA DUSTER

2014-2018



POLISHED: DUSTER-R1060-04
BLACK: DUSTER-R1060-04-B



POLISHED: DUSTER-R1060-03
BLACK: DUSTER-R1060-03-B



POLISHED: DUSTER-R1060-00
BLACK: DUSTER-R1060-00-B

DACIA SANDERO STEPAWAY

2012-2016

FIAT DUCATO

2006-2014



POLISHED: STEPWAY-R1260-00
BLACK: STEPWAY-R1260-00-B

POLISHED: DUCATO-R0070
BLACK: DUCATO-R0070-B

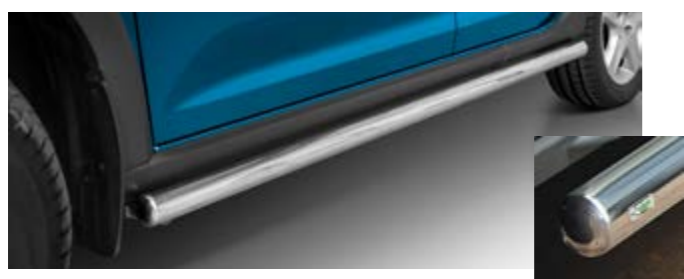

POLISHED: STEPWAY-R1260-R
BLACK: STEPWAY-R1260-R-B

POLISHED: STEPWAY-R1260-06
BLACK: STEPWAY-R1260-06-B

POLISHED: DUCATO-R0070-03
BLACK: DUCATO-R0070-03-B



POLISHED: STEPWAY-R1260-03
BLACK: STEPWAY-R1260-03-B

POLISHED: STEPWAY-R1260-04
BLACK: STEPWAY-R1260-04-B

POLISHED: DUCATO-R0070-04
BLACK: DUCATO-R0070-04-B

POLISHED: DUCATO-R0070-06
BLACK: DUCATO-R0070-06-B

FIAT DUCATO
2014-2016-



POLISHED: DUCATO-R0070
BLACK: DUCATO-R0070-B



POLISHED: DUCATO-R0070-03
BLACK: DUCATO-R0070-03-B



POLISHED: DUCATO-R0070-06
BLACK: DUCATO-R0070-06-B



POLISHED: DUCATO-R0070-04
BLACK: DUCATO-R0070-04-B

FIAT FULLBACK
2015-



POLISHED: FULLBACK-L1570-08



POLISHED: FULLBACK-R1770-PR



POLISHED: FULLBACK-R1776-PR-01



POLISHED: FULLBACK-R1770-PR-02



POLISHED: FULLBACK-R17100-PR-01

FIAT FULLBACK 2015-



POLISHED: FULLBACK-R1570-03



POLISHED: FULLBACK-R1570-06



BLACK: FULLBACK-R1570-03-B



BLACK: FULLBACK-R1570-06-B



POLISHED: FULLBACK-R1570-04



POLISHED: FULLBACK-L1570-05



BLACK: FULLBACK-R1570-04-B



BLACK: FULLBACK-L1570-05-B



POLISHED: FULLBACK-R1570-00



POLISHED: FULLBACK-L1570-07



BLACK: FULLBACK-R1570-00-B



BLACK: FULLBACK-L1570-07-B



BLACK: FULLBACK-L1570-08-B



BLACK: FULLBACK-R1770-PR-B



BLACK: FULLBACK-R1776-PR-01-B



BLACK: FULLBACK-R1770-PR-02-B



BLACK: FULLBACK-R17100-PR-01-B



POLISHED: FULLBACK-R1770-GR



POLISHED: FULLBACK-R1776-GR



BLACK: FULLBACK-R1770-GR



BLACK: FULLBACK-R1776-GR

FORD CONNECT
2013-2018



POLISHED: CONNECT-R1360-00
BLACK: CONNECT-R1360-00-B

FORD COURIER
2014-2018



POLISHED: COURIER-R1460
BLACK: COURIER-R1460-B



POLISHED: CONNECT-R1360-03
BLACK: CONNECT-R1360-03-B



POLISHED: CONNECT-R1360-04
BLACK: CONNECT-R1360-03-B



POLISHED: CONNECT-R1360-06
BLACK: CONNECT-R1360-06-B



POLISHED: COURIER-R1460-03
BLACK: COURIER-R1460-03-B



POLISHED: CONNECT-R1348-R-LWB
BLACK: CONNECT-R1348-R-LWB-B



POLISHED: CONNECT-R1348-R-LWB
BLACK: ONNECT-R1348-R-LWB-B



POLISHED: CONNECT-R1348-R-LWB
BLACK: CONNECT-R1348-R-LWB-B



POLISHED: COURIER-R1448-R
BLACK: COURIER-R1448-R-B



POLISHED: COURIER-R1460-04
BLACK: COURIER-R1460-04-B

FORD KUGA

2008-2013



POLISHED: K-R0060-03
BLACK: K-R0060-03-B



POLISHED: K-R0060-04
BLACK: K-R0060-04



POLISHED: K-R0076-05
BLACK: K-R0076-05-B



POLISHED: K-R0076-06
BLACK: K-R0076-06-B

POLISHED: K-R0060
BLACK: K-R0060-B



POLISHED: K-R0070-R
BLACK: K-R0070-R-B



POLISHED: K-R0070-PR-01
BLACK: K-R0070-PR-01-B



POLISHED: K-R0070-PR-02
BLACK: K-R0070-PR-02-B

POLISHED: K-R0070-NR
BLACK: K-R0070-NR-B



FORD KUGA 2012-2017



POLISHED: K-R1360-04
BLACK: K-R1360-04-B



POLISHED: K-R1360-R
BLACK: K-R1360-R-B



POLISHED: K-R1360-PR
BLACK: K-R1360-PR-B



POLISHED: K-R1376-PR-01
BLACK: K-R1376-PR-01-B



POLISHED: K-R1370-PR-02
BLACK: K-R1370-PR-02-B



POLISHED: K-R1360-03
BLACK: K-R1360-03-B



POLISHED: K-R1360
BLACK: K-R1360-B



POLISHED: K-R1360-06
BLACK: K-R1360-06-B



POLISHED: K-R1370
BLACK: K-R1370-B



POLISHED: K-R1370-03
BLACK: K-R1370-03-B



POLISHED: K-R1370-04
BLACK: K-R1370-04-B



POLISHED: K-R1370-NR
BLACK: K-R1370-NR-B

FORD KUGA 2017-



POLISHED: K-L1770-08
BLACK: K-L1770-08-B



POLISHED: K-R1760-03
BLACK: K-R1760-03-B



POLISHED: K-R1760-06
BLACK: K-R1760-06-B



POLISHED: K-R1760-00
BLACK: K-R1760-00-B



POLISHED: K-R1760-04
BLACK: K-R1760-04-B



POLISHED: K-L1770-05
BLACK: K-L1770-05-B



POLISHED: K-L1770-07
BLACK: K-L1770-07-B



POLISHED: K-R1760-R
BLACK: K-R1760-R-B



POLISHED: K-R1770-PR
BLACK: K-R1770-PR-B



POLISHED: K-R1770-PR-02
BLACK: K-R1770-PR-02-B



POLISHED: K-R1776-PR-01
BLACK: K-R1776-PR-01-B

FORD RANGER

2007-2012



POLISHED: RANGER-R0085-00
BLACK: RANGER-R0085-00-B



POLISHED: RANGER-R0076-04
BLACK: RANGER-R0076-04-B



POLISHED: RANGER-R0076-06
BLACK: RANGER-R0076-06-B



POLISHED: RANGER-R0085-03
BLACK: RANGER-R0085-03-B



POLISHED: RANGER-R0085-04
BLACK: RANGER-R0085-04-B



POLISHED: RANGER-R0085-06
BLACK: RANGER-R0085-06-B



POLISHED: RANGER-R0085-PR
BLACK: RANGER-R0085-PR-B



POLISHED: RANGER-R0085-PR-01
BLACK: RANGER-R0085-PR-01-B



POLISHED: RANGER-R0085-PR-02
BLACK: RANGER-R0085-PR-02-B



POLISHED: RANGER-R0076-GR
BLACK: RANGER-R0076-GR-B

FORD RANGER

2012-2016



POLISHED: R12-R1285-00
BLACK: R12-R1285-00-B



POLISHED: R12-R1276-03
BLACK: R12-R1276-03-B



POLISHED: R12-R1276-04
BLACK: R12-R1276-04-B



POLISHED: R12-R1276-06
BLACK: R12-R1276-06-B



POLISHED: R12-R1285-03
BLACK: R12-R1285-03-B



POLISHED: R12-R1285-04
BLACK: R12-R1285-04-B



POLISHED: R12-R1285-06
BLACK: R12-R1285-06-B



POLISHED: R12-R1285-PR
BLACK: R12-R1285-PR-B



POLISHED: R12-R1285-PR-01
BLACK: R12-R1285-PR-01-B



POLISHED: R12-R1285-PR-02
BLACK: R12-R1285-PR-02-B



POLISHED: R12-R1276-GR
BLACK: R12-R1276-GR-B

FORD RANGER 2016-



POLISHED: R12-R1285-04



POLISHED: R16-L1670-05



POLISHED: R16-L1670-08



POLISHED: R16-L1670-07



POLISHED: R12-R1285-03



POLISHED: R12-R1285-00



POLISHED: R12-R1285-06



POLISHED: R12-R1285-PR-01



POLISHED: R12-R1285-PR-02



BLACK: R12-R1285-PR-01-B



BLACK: R12-R1285-PR-02-B



POLISHED: R12-R1285-PR



BLACK: R12-R1285-PR-B

FORD RANGER

2016-



BLACK: R16-L1670-05-B



BLACK: R16-L1670-08-B



BLACK: R16-L1670-07-B



BLACK: R12-R1285-03-B



BLACK: R12-R1285-06-B



BLACK: R12-R1285-06-B



BLACK: R12-R1285-04-B



POLISHED: R12-R1276-GR



BLACK: R12-R1276-GR-B

FORD TRANSIT

2006-2014



POLISHED: TRANSIT-R0070-04
BLACK: TRANSIT-R0070-04-B



POLISHED: TRANSIT-R0070
BLACK: TRANSIT-R0070-B



POLISHED: TRANSIT-R0070-03
BLACK: TRANSIT-R0070-03-B



POLISHED: TRANSIT-R0070-06
BLACK: TRANSIT-R0070-06-B



POLISHED: TRANSIT-R0070-R
BLACK: TRANSIT-R0070-R-B



POLISHED: TRANSIT-R0076-PR-01
BLACK: TRANSIT-R0076-PR-01-B



POLISHED: TRANSIT-R0070-PR-02
BLACK: TRANSIT-R0070-PR-02-B

FORD TRANSIT

2014-



POLISHED: TRANSIT-R1370-04
BLACK: TRANSIT-R1370-04-B



POLISHED: TRANSIT-R1370-00
BLACK: TRANSIT-R1370-00-B



POLISHED: TRANSIT-R1370-03
BLACK: TRANSIT-R1370-03-B



POLISHED: TRANSIT-R1370-06
BLACK: TRANSIT-R1370-06-B



POLISHED: TRANSIT-R1370-R-L3
BLACK: TRANSIT-R1370-R-L3-B



POLISHED: TRANSIT-R1376-PR-01-L3
BLACK: TRANSIT-R1376-PR-01-L3-B



POLISHED: TRANSIT-R1370-PR-02-L3
BLACK: TRANSIT-R1370-PR-02-L3-B

FORD TRANSIT CUSTOM

2012-2018



POLISHED: CUSTOM-R1276-04
BLACK: CUSTOM-R1276-04-B



POLISHED: CUSTOM-R1270-R-L2
BLACK: CUSTOM-R1270-R-L2-B



POLISHED: CUSTOM-R1276-PR-01-L2
BLACK: CUSTOM-R1276-PR-01-L2-B

FORD TRANSIT CUSTOM

2012-2018

HONDA CRV

2006-2009



POLISHED: CUSTOM-R1270
BLACK: CUSTOM-R1270-B



POLISHED: CUSTOM-R1270-03
BLACK: CUSTOM-R1270-03-B



POLISHED: CUSTOM-R1270-04
BLACK: CUSTOM-R1270-04-B



POLISHED: CUSTOM-R1270-06
BLACK: CUSTOM-R1270-06-B



POLISHED: CUSTOM-R1276-03
BLACK: CUSTOM-R1276-03-B



POLISHED: CUSTOM-R1276-06
BLACK: CUSTOM-R1276-06-B



POLISHED: CUSTOM-R1270-PR-02-L2
BLACK: CUSTOM-R1270-PR-02-L2-B



POLISHED: CRV-R0070-06
BLACK: CRV-R0070-06-B



POLISHED: CRV-R0060-R
BLACK: CRV-R0060-R-B



POLISHED: CRV-R0060-PR
BLACK: CRV-R0060-PR-B



POLISHED: CRV-R0076-PR-01
BLACK: CRV-R0076-PR-01-B



POLISHED: CRV-R0070-PR-02
BLACK: CRV-R0070-PR-02-B

HONDA CRV

2012-2016



POLISHED: CRV-R1260
BLACK: CRV-R1260-B



POLISHED: CRV-R1260-03
BLACK: CRV-R1260-03-B



POLISHED: CRV-R1260-04
BLACK: CRV-R1260-04-B



POLISHED: CRV-R1260-06
BLACK: CRV-R1260-06-B



POLISHED: CRV-R1270-03 (2012-2015)
BLACK: CRV-R1270-03-B (2012-2015)



POLISHED: CRV-R1270-04 (2012-2015)
BLACK: CRV-R1270-04-B (2012-2015)



POLISHED: CRV-R1270-05 (2012-2015)
BLACK: CRV-R1270-05-B (2012-2015)



POLISHED: CRV-R1260-R
BLACK: CRV-R1260-R-B



POLISHED: CRV-R1270-PR
BLACK: CRV-R1270-PR-B



POLISHED: CRV-R1276-PR-01
BLACK: CRV-R1276-PR-01-B



POLISHED: CRV-R1270-PR-02
BLACK: CRV-R1270-PR-02-B

POLISHED: CRV-R1248-NR
BLACK: CRV-R1248-NR-B



HONDA CRV 2016-

POLISHED: CRV-R1260-04
BLACK: CRV-R1260-04-B



POLISHED: CRV-R1260-03
BLACK: CRV-R1260-03-B



POLISHED: CRV-R1260-06
BLACK: CRV-R1260-06-B



POLISHED: CRV-R1260-R
BLACK: CRV-R1260-R-B



POLISHED: CRV-R1276-PR-01
BLACK: CRV-R1276-PR-01-B



POLISHED: CRV-R1270-PR-02-B
BLACK: CRV-R1270-PR-02

HYUNDAI IX35 2010-2013-2015



POLISHED: IX35-R1076-04
BLACK: IX35-R1076-04-B



POLISHED: IX35-R1060-R
BLACK: IX35-R1060-R-B



POLISHED: IX35-R1076-PR-01
BLACK: IX35-R1076-PR-01-B

HYUNDAI IX35

2010-2013-2015



POLISHED: IX35-R1070
BLACK: IX35-R1070-B



POLISHED: IX35-R1070-03
BLACK: IX35-R1070-03-B



POLISHED: IX35-R1070-04
BLACK: IX35-R1070-04-B



POLISHED: IX35-R1070-06
BLACK: IX35-R1070-06-B



POLISHED: IX35-R1076-03
BLACK: IX35-R1076-03-B



POLISHED: IX35-R1070-PR-02
BLACK: IX35-R1070-PR-02-B



POLISHED: IX35-R1070-NR
BLACK: IX35-R1070-NR-B

HYUNDAI SANTA-FE

2012-2018



POLISHED: SANTA-FE-R1270
BLACK: SANTA-FE-R1270-B



POLISHED: SANTA-FE-R1260-R
BLACK: SANTA-FE-R1260-R-B



POLISHED: SANTA-FE-R1270-PR
BLACK: SANTA-FE-R1270-PR-B



POLISHED: SANTA-FE-R1276-PR-01
BLACK: SANTA-FE-R1276-PR-01-B



POLISHED: SANTA-FE-R1270-PR-02
BLACK: SANTA-FE-R1270-PR-02-B

HYUNDAI SANTA-FE 2012-2018



POLISHED: SANTA-FE-R1270-03
BLACK: SANTA-FE-R1270-03-B



POLISHED: SANTA-FE-R1270-04
BLACK: SANTA-FE-R1270-04-B



POLISHED: SANTA-FE-R1270-06
BLACK: SANTA-FE-R1270-06-B



POLISHED: SANTA-FE-R1276-00
BLACK: SANTA-FE-R1276-00-B



POLISHED: SANTA-FE-R1276-03
BLACK: SANTA-FE-R1276-03-B



POLISHED: SANTA-FE-R1276-04
BLACK: SANTA-FE-R1276-04-B

POLISHED: SANTA-FE-R1270-NR
BLACK: SANTA-FE-R1270-NR-B



HYUNDAI TUCSON 2015-



POLISHED: TUCSON-R1570-00
BLACK: TUCSON-R1570-00-B



POLISHED: TUCSON-R1560-R
BLACK: TUCSON-R1560-R-B



POLISHED: TUCSON-R1576-PR-01
BLACK: TUCSON-R1576-PR-01-B

HYUNDAI TUCSON

2015-



POLISHED: TUCSON-R1570-06
BLACK: TUCSON-R1570-06-B



POLISHED: TUCSON-R1570-03
BLACK: TUCSON-R1570-03-B



POLISHED: TUCSON-R1570-04
BLACK: TUCSON-R1570-04-B



POLISHED: TUCSON-L1560-05
BLACK: TUCSON-L1560-05-B



POLISHED: TUCSON-L1560-08
BLACK: TUCSON-L1560-08-B



POLISHED: TUCSON-R1570-PR-02
BLACK: TUCSON-R1570-PR-02-B

ISUZU D-MAX

2012-2017



POLISHED: D-MAX-R1270-00
BLACK: D-MAX-R1270-00-B



POLISHED: D-MAX-R1260-R
BLACK: D-MAX-R1260-R-B



POLISHED: D-MAX-R1270-PR
BLACK: D-MAX-R1270-PR-B



POLISHED: D-MAX-R1276-PR-01
BLACK: D-MAX-R1276-PR-01-B



POLISHED: D-MAX-R1270-PR-02
BLACK: D-MAX-R1270-PR-02-B

ISUZU D-MAX 2012-2017



POLISHED: D-MAX-R1270-03
BLACK: D-MAX-R1270-03-B



POLISHED: D-MAX-R1270-04
BLACK: D-MAX-R1270-04-B



POLISHED: D-MAX-R1270-06
BLACK: D-MAX-R1270-06-B



POLISHED: D-MAX-R1276
BLACK: D-MAX-R1276-B



POLISHED: D-MAX-R1276-03
BLACK: D-MAX-R1276-03-B



POLISHED: D-MAX-R1276-04
BLACK: D-MAX-R1276-04-B



POLISHED: D-MAX-R1276-GR
BLACK: D-MAX-R1276-GR-B

ISUZU D-MAX 2017-



POLISHED: D-MAX-R1270-04
BLACK: D-MAX-R1270-04-B



POLISHED: D-MAX-R1260-R



POLISHED: D-MAX-R1270-PR



POLISHED: D-MAX-R1276-PR-01-B



POLISHED: D-MAX-R1270-PR-02

ISUZU D-MAX 2017-



POLISHED: D-MAX-R1270-03



POLISHED: D-MAX-R1270-06



BLACK: D-MAX-R1270-03-B



BLACK: D-MAX-R1270-06-B



POLISHED: D-MAX-R1270-00



POLISHED: D-MAX-R1276-03



BLACK: D-MAX-R1270-00-B



BLACK: D-MAX-R1270-00-B



POLISHED: D-MAX-R1276-04



POLISHED: D-MAX-R1276



BLACK: D-MAX-R1276-04-B



BLACK: D-MAX-R1276-03-B



BLACK: D-MAX-R1260-R-B



BLACK: D-MAX-R1270-PR-B



BLACK: D-MAX-R1276-B



BLACK: D-MAX-R1276-PR-01-B



BLACK: D-MAX-R1270-PR-02-B



POLISHED: D-MAX-R1276



BLACK: D-MAX-R1276-B

Isuzu D-MAX - AT35



AFTER CONVERSION

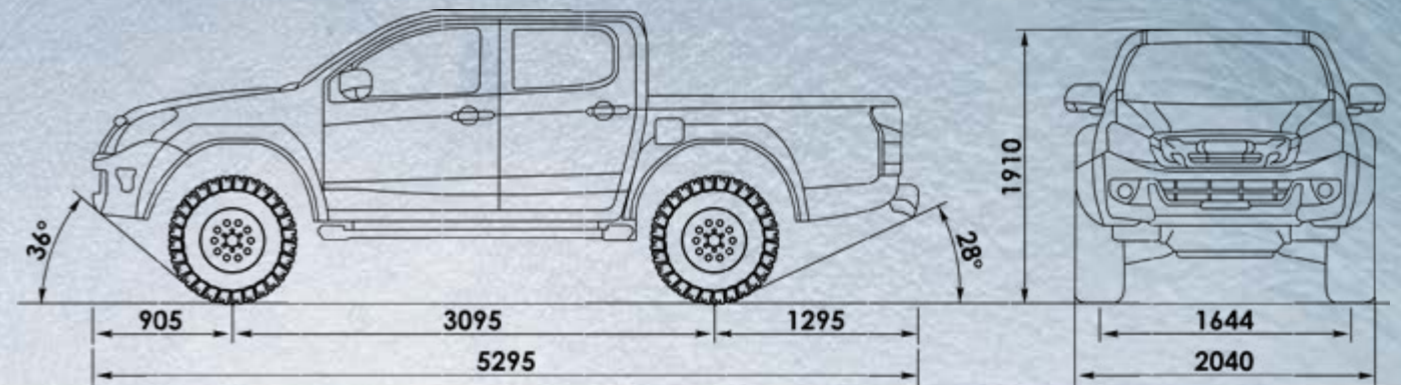

Choose your suspension

Choose your tyres



Old Man Emu suspension



OME BP-51 suspension



BF Goodrich A/T KO2 315/70 R17

Nokian Hakkapeliita LT 2 315/70 R17

When we convert D-MAX to 35" tires, we lift the suspension 30 mm and the body - 20mm. Extra fender flares are used which gives your PICK-UP a powerful look and separates it from all others. With the AT35 you can take your PICK-UP to almost any mountain road in the world, without having any trouble.

The AT35 will give you much grater ground clearance, better traction, softer ride, higher seating and most of all a feeling of confidence. Also will it give you the possibility to deflate your tires, so that you get a better flotation in snow, sand and mud.

The AT35 is ideal for hunters, farmers and park rangers, or just for those who want something different from the rest.

- 315x70 R17" tires BFG AT KO2 or Nokian Hakkapeliitta LT2 „Arctic Trucks”
- 17x10" alloy wheels
- Torque wrench
- Fender flares, painted
- Running boards and brackets
- Mud flaps
- Speedometer calibrator
- 30 mm OME suspension lift, front/rear
- 20 mm body lift
- Fender trimming, front/rear
- First aid kit
- Wheel alignment

Modification cost with OME suspension: 9 200 euro net
Delivery to our location not included.
Stainless steel products and additional lamps are not included.
Lead time: 15 working days.
Payment: 10% with the order 90% before car pick up.

Contact:
e-mail: info@arctictrucks.pl
phone: +48 85 711 95 58



STEELER
ul. Grodzienska 206
16-100 Sokolka
Poland
NIP: 545-161-39-48
www.arctictrucks.pl

JEEP GRAND CHEROKEE

2011-2014



POLISHED: GCH-L1060-05
BLACK: GCH-L1060-05-B



POLISHED: GCH-R1070-06
BLACK: GCH-R1070-06 -B



POLISHED: GCH-R1060-R
BLACK: GCH-R1060-R-B



POLISHED: GCH-R1070-PR-02
BLACK: GCH-R1070-PR-02-B



POLISHED: GCH-R1076-PR-01
BLACK: GCH-R1076-PR-01 -B

JEEP GRAND CHEROKEE

2015-



POLISHED: GCH-R1570-06
BLACK: GCH-R1570-06-B



POLISHED: GCH-L1570-05-B
BLACK: GCH-L1570-05



POLISHED: GCH-R1560-R-B
BLACK: GCH-R1560-R



POLISHED: GCH-R1570-PR-02-B
BLACK: GCH-R1570-PR-02



POLISHED: GCH-R1576-PR-01
BLACK: GCH-R1576-PR-01-B

JEEP RENEGADE 2014-



POLISHED: RENEGADE-R1460-03
BLACK: RENEGADE-R1460-03-B



POLISHED: RENEGADE-R1460-04
BLACK: RENEGADE-R1460-04-B



POLISHED: RENEGADE-L1460-09
BLACK: RENEGADE-L1460-09-B



POLISHED: RENEGADE-L1460-10
BLACK: RENEGADE-L1460-10-B

POLISHED: RENEGADE-R1460-00
BLACK: RENEGADE-R1460-00-B



POLISHED: RENEGADE-R1460-R
BLACK: RENEGADE-R1460-R-B



POLISHED: RENEGADE-R1470-PR-02
BLACK: RENEGADE-R1470-PR-02-B



POLISHED: RENEGADE-R1476-PR-01
BLACK: RENEGADE-R1476-PR-01-B



KIA SORENTO

2010-2012



POLISHED: SOR-R0070-04
BLACK: SOR-R0070-04-B



POLISHED: SOR-R0070
BLACK: SOR-R0070-B



POLISHED: SOR-R0070-03
BLACK: SOR-R0070-03-B



POLISHED: SOR-R0070-06
BLACK: SOR-R0070-06-B



POLISHED: SOR-R0076-03
BLACK: SOR-R0076-03-B



POLISHED: SOR-R0076-04
BLACK: SOR-R0076-04-B



POLISHED: SOR-R0060-R
BLACK: SOR-R0060-R-B



POLISHED: SOR-R0070-PR
BLACK: SOR-R0070-PR-B



POLISHED: SOR-R0076-PR-01
BLACK: SOR-R0076-PR-01-B



POLISHED: SOR-R0070-PR-02
BLACK: SOR-R0070-PR-02-B



POLISHED: SOR-R0070-NR
BLACK: SOR-R0070-NR-B

KIA SORENTO

2012-2015



POLISHED: SOR-R1276-06
BLACK: SOR-R1276-06-B



POLISHED: SOR-R1260-R
BLACK: SOR-R1260-R-B



POLISHED: SOR-R1270-PR
BLACK: SOR-R1270-PR-B



POLISHED: SOR-R1276-PR-01
BLACK: SOR-R1276-PR-01-B



POLISHED: SOR-R1270-PR-02
BLACK: SOR-R1270-PR-02-B



POLISHED: SOR-R1270
BLACK: SOR-R1270-B



POLISHED: SOR-R1270-03
BLACK: SOR-R1270-03-B



POLISHED: SOR-R1270-04
BLACK: SOR-R1270-04-B



POLISHED: SOR-R1270-06
BLACK: SOR-R1270-06-B



POLISHED: SOR-R1276-03
BLACK: SOR-R1276-03-B



POLISHED: SOR-R1276-04
BLACK: SOR-R1276-04-B

POLISHED: SOR-R1270-NR
BLACK: SOR-R1270-NR-B



KIA SORENTO

2015-2018



POLISHED: SOR-R1570-04
BLACK: SOR-R1570-04-B



POLISHED: SOR-R1560-R
BLACK: SOR-R1560-R-B



POLISHED: SOR-R1570-PR
BLACK: SOR-R1570-PR-B



POLISHED: SOR-R1576-PR-01
BLACK: SOR-R1576-PR-01-B



POLISHED: SOR-R1570-PR-02
BLACK: SOR-R1570-PR-02-B



POLISHED: SOR-R1570
BLACK: SOR-R1570-B



POLISHED: SOR-R1570-03
BLACK: SOR-R1570-03-B



POLISHED: SOR-R1570-06
BLACK: SOR-R1570-06-B



POLISHED: SOR-L1570-05
BLACK: SOR-L1570-05-B



POLISHED: SOR-L1570-08
BLACK: SOR-L1570-08-B



POLISHED: SOR-L1570-07
BLACK: SOR-L1570-07-B

POLISHED: SOR-R1570-NR
BLACK: SOR-R1570-NR-B



KIA SOUL
2008-2013

KIA SPORTAGE
2008-2010



POLISHED: SOUL-R0060-04
BLACK: SOUL-R0060-04-B



POLISHED: SPOR-R0070
BLACK: SPOR-R0070-B



POLISHED: SOUL-R0060-03
BLACK: SOUL-R0060-03-B



POLISHED: SOUL-R0060-R
BLACK: SOUL-R0060-R-B



POLISHED: SPOR-R0060-R
BLACK: SPOR-R0060-R-B



POLISHED: SPOR-R0070-PR
BLACK: SPOR-R0070-PR-B



POLISHED: SOUL-R0060-05
BLACK: SOUL-R0060-05-B



POLISHED: SPOR-R0076-PR-01
BLACK: SPOR-R0076-PR-01-B



POLISHED: SPOR-R0070-PR-02
BLACK: SPOR-R0070-PR-02-B

KIA SPORTAGE

2008-2010



POLISHED: SPOR-R0070-03
BLACK: SPOR-R0070-03-B



POLISHED: SPOR-R0070-04
BLACK: SPOR-R0070-04-B



POLISHED: SPOR-R0070-06
BLACK: SPOR-R0070-06-B



POLISHED: SPOR-R0076-03
BLACK: SPOR-R0076-03-B



POLISHED: SPOR-R0076-04
BLACK: SPOR-R0076-04-B



POLISHED: SPOR-R0070-NR
BLACK: SPOR-R0070-NR-B

KIA SPORTAGE

2010-2015



POLISHED: SPOR-R1070-00
BLACK: SPOR-R1070-00-B



POLISHED: SPOR-R1060-R
BLACK: SPOR-R1060-R-B



POLISHED: SPOR-R1070-PR
BLACK: SPOR-R1070-PR-B



POLISHED: SPOR-R1076-PR-01
BLACK: SPOR-R1076-PR-01-B

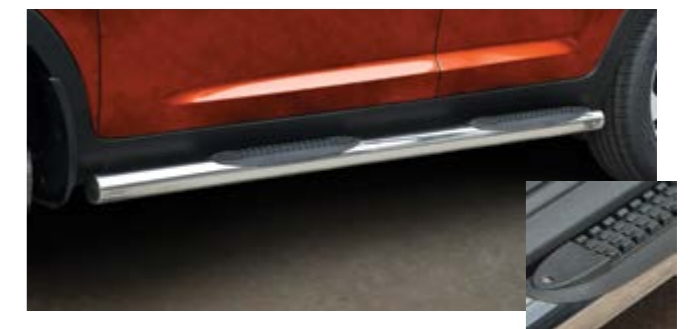

POLISHED: SPOR-R1070-PR-02
BLACK: SPOR-R1070-PR-02-B

KIA SPORTAGE

2010-2015



POLISHED: SPOR-R0070-03
BLACK: SPOR-R0070-03-B



POLISHED: SPOR-R1070-04
BLACK: SPOR-R1070-04-B



POLISHED: SPOR-R1070-06
BLACK: SPOR-R1070-06-B



POLISHED: SPOR-R1076-03
BLACK: SPOR-R1076-03-B



POLISHED: SPOR-R1076-04
BLACK: SPOR-R1076-04-B



POLISHED: SPOR-R1070-NR
BLACK: SPOR-R1070-NR-B

KIA SPORTAGE

2015-2018



POLISHED: SPOR-R1570-00
BLACK: SPOR-R1570-00-B



POLISHED: SPOR-R1570-R
BLACK: SPOR-R1570-R-B



POLISHED: SPOR-R1570-PR-02
BLACK: SPOR-R1570-PR-02-B

KIA SPORTAGE
2015-2018



POLISHED: SPOR-R1570-04
BLACK: SPOR-R1570-04-B



POLISHED: SPOR-R1570-03
BLACK: SPOR-R1570-03-B



POLISHED: SPOR-R1570-06
BLACK: SPOR-R1570-06-B



POLISHED: SPOR-L1570-05
BLACK: SPOR-L1570-05-B



POLISHED: SPOR-L1570-08
BLACK: SPOR-L1570-08-B



POLISHED: SPOR-R1580-PR-04
BLACK: SPOR-R1580-PR-04-B

LAND ROVER FREELANDER II
2007-2014



POLISHED: FREE2-R0070-06
BLACK: FREE2-R0070-06-B



POLISHED: FREE2-R0060-R
BLACK: FREE2-R0060-R-B



POLISHED: FREE2-R0070-PR-02
BLACK: FREE2-R0070-PR-02-B

LAND ROVER FREELANDER II

2007-2014



POLISHED: FREE2-R0070-S
BLACK: FREE2-R0070-S-B



POLISHED: FREE2-R0070-03
BLACK: FREE2-R0070-03-B



POLISHED: FREE2-R0070-04
BLACK: FREE2-R0070-04-B



POLISHED: FREE2-R0070-00
BLACK: FREE2-R0070-00-B



POLISHED: FREE2-R0076-PR-01
BLACK: FREE2-R0076-PR-01-B

LEXUS NX F-SPORT

2014-



POLISHED: NX-R1470-04
BLACK: NX-R1470-04-B



POLISHED: NX-R1470-06
BLACK: NX-R1470-06-B



POLISHED: NX-R1470-03
BLACK: NX-R1470-03-B



POLISHED: NX-R1460-08
BLACK: NX-R1460-08-B



POLISHED: NX-R1460-R
BLACK: NX-R1460-R-B



POLISHED: NX-R1470-PR-02
BLACK: NX-R1470-PR-02-B

MERCEDES SPRINTER
2006-2013-2018



POLISHED: SPRINTER-R0070-04
BLACK: SPRINTER-R0070-04-B



POLISHED: SPRINTER-R0070
BLACK: SPRINTER-R0070-B



POLISHED: SPRINTER-R0070-03
BLACK: SPRINTER-R0070-03-B

MERCEDES V-CLASS
2014-



POLISHED: V-CLASS-R1470-00
BLACK: V-CLASS-R1470-00-B



POLISHED: V-R1460-R-SWB / V-R1460-R-LWB
BLACK: V-R1460-R-SWB-B / V-R1460-R-LWB-B



POLISHED: V-R1470-PR-02-SWB / V-R1470-PR-02-LWB
BLACK: V-R1470-PR-02-SWB-B / V-R1470-PR-02-LWB-B

MERCEDES V-CLASS

2014-



POLISHED: V-CLASS-R1470-03
BLACK: V-CLASS-R1470-03-B



POLISHED: V-CLASS-R1470-04
BLACK: V-CLASS-R1470-04-B



POLISHED: V-CLASS-L1470-05
BLACK: V-CLASS-L1470-05-B



POLISHED: V-CLASS-L1470-08
BLACK: V-CLASS-L1470-08-B



POLISHED: V-R1476-PR-01-SWB / V-R1476-PR-01-LWB
BLACK: V-R1476-PR-01-SWB-B / V-R1476-PR-01-LWB-B

MERCEDES VITO

2003-2010



POLISHED: V-R0060-00
BLACK: V-R0060-00-B



POLISHED: V-R0060-03
BLACK: V-R0060-03-B



POLISHED: V-R0060-04
BLACK: V-R0060-04-B



POLISHED: V-R0060-06
BLACK: V-R0060-06-B



POLISHED: V-R0060-R
BLACK: V-R0060-R-B



POLISHED: V-R0076-PR-01
BLACK: V-R0076-PR-01-B



POLISHED: V-R0070-PR-02
BLACK: V-R0070-PR-02-B

MERCEDES VITO 2014-



POLISHED: VITO-R1470-04
BLACK: VITO-R1470-04-B



POLISHED: VITO-R1470-03
BLACK: VITO-R1470-03-B



POLISHED: VITO-R1470-00
BLACK: VITO-R1470-00-B



POLISHED: VITO-R1470-06
BLACK: VITO-R1470-06-B



POLISHED: VITO-L1470-05
BLACK: VITO-L1470-05-B



POLISHED: VITO-L1470-08
BLACK: VITO-L1470-08-B

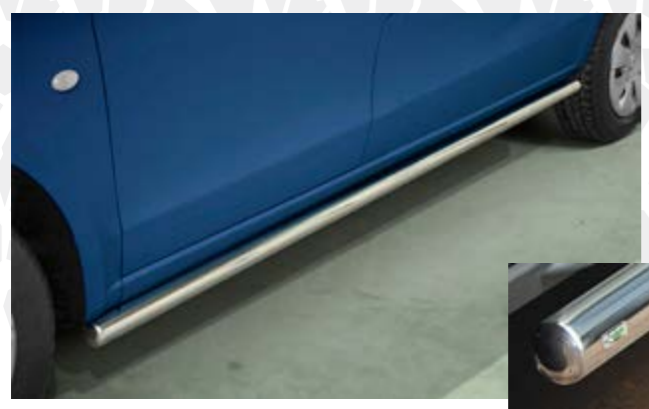

POLISHED: V-R1460-R-SWB / V-R1460-R-LWB
BLACK: V-R1460-R-SWB-B / V-R1460-R-LWB-B



POLISHED: V-R1470-PR-02-SWB / V-R1470-PR-02-LWB
BLACK: V-R1470-PR-02-SWB-B / V-R1470-PR-02-LWB-B



POLISHED: V-R1476-PR-01-SWB / V-R1476-PR-01-LWB
BLACK: V-R1476-PR-01-SWB-B / V-R1476-PR-01-LWB-B

MERCEDES X-CLASS

2017-



POLISHED: X-R1770-04



POLISHED: X-R1770-06



POLISHED: X-L1770-05



POLISHED: X-R1770-03



POLISHED: X-L1770-08



POLISHED: X-R1770-00



POLISHED: X-L1770-07

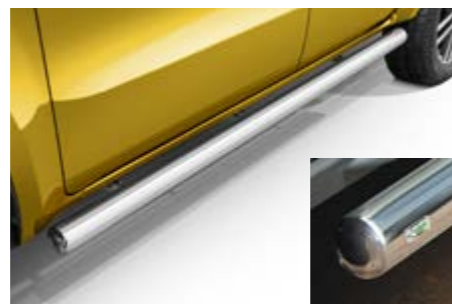

POLISHED: X-R1770-R



POLISHED: X-R1770-PR-02



POLISHED fi70: X-R1776-PR-01

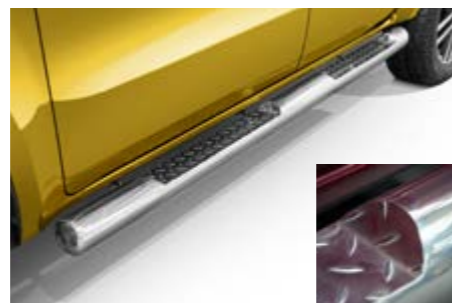

POLISHED fi100: X-R17100-PR-01

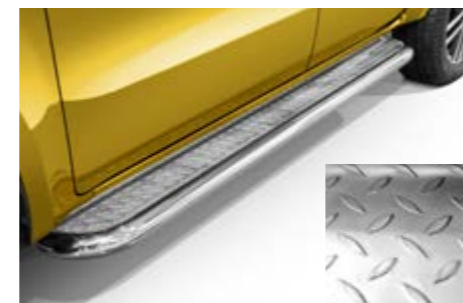

POLISHED: X-R1770-PR



BLACK: X-R1770-R -B



BLACK: X-R1770-PR-02-B



BLACK fi70: X-R1776-PR-01-B



BLACK fi100: X-R17100-PR-01-B

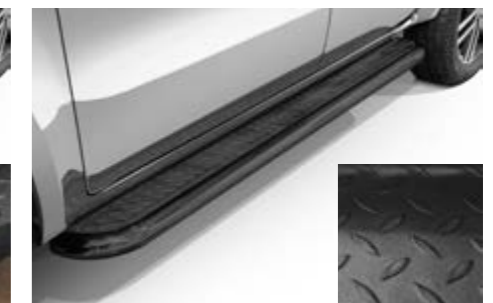

POLISHED: X-R1770-PR

MERCEDES X-CLASS

2017-



BLACK: X-R1770-06-B



BLACK: X-R1770-03-B



BLACK: X-R1770-00-B



BLACK: X-R1770-04-B



POLISHED: X-R1776-GR



BLACK: X-R1776-GR-B



BLACK: X-L1770-05-B



BLACK: X-L1770-08-B



BLACK: X-L1770-07-B



POLISHED: X-R1770-GR



BLACK: X-R1770-GR-B

MITSUBISHI ASX

2010-2013



POLISHED: ASX-R1060
BLACK: ASX-R1060-B



POLISHED: ASX-R1060-R
BLACK: ASX-R1060-R-B



POLISHED: ASX-R1060-PR-B
BLACK: ASX-R1060-PR



POLISHED: ASX-R1076-PR-01
BLACK: ASX-R1076-PR-01-B



POLISHED: ASX-R1070-PR-02
BLACK: ASX-R1070-PR-02-B

MITSUBISHI ASX

2010-2013



POLISHED: ASX-R1060-03
BLACK: ASX-R1060-03-B



POLISHED: ASX-R1060-04
BLACK: ASX-R1060-04-B



POLISHED: ASX-R1060-06
BLACK: ASX-R1060-06-B



POLISHED: ASX-R1076-03
BLACK: ASX-R1076-03-B



POLISHED: ASX-R1076-04
BLACK: ASX-R1076-04-B



POLISHED: ASX-R1048-NR
BLACK: ASX-R1048-NR-B

MITSUBISHI ASX

2012-2017



POLISHED: ASX-R1360
BLACK: ASX-R1360-B



POLISHED: ASX-R1360-R
BLACK: ASX-R1360-R-B



POLISHED: ASX-R1360-PR
BLACK: ASX-R1360-PR-B



POLISHED: ASX-R1376-PR-01
BLACK: ASX-R1376-PR-01-B



POLISHED: ASX-R1370-PR-02
BLACK: ASX-R1370-PR-02-B

MITSUBISHI ASX
2012-2017



POLISHED: ASX-R1360-03
BLACK: ASX-R1360-03-B



POLISHED: ASX-R1360-04
BLACK: ASX-R1360-04-B



POLISHED: ASX-R1376-03
BLACK: ASX-R1376-03-B



POLISHED: ASX-R1376-04
BLACK: ASX-R1376-04-B

MITSUBISHI ASX
2017-



POLISHED: ASX-R1760-00
BLACK: ASX-R1760-00-B



POLISHED: ASX-R1348-NR
BLACK: ASX-R1348-NR-B



POLISHED: ASX-R1760-R
BLACK: ASX-R1760-R-B



POLISHED: ASX-R1770-PR-02
BLACK: ASX-R1770-PR-02-B

MITSUBISHI ASX

2017-



POLISHED: ASX-R1060-03
BLACK: ASX-R1060-03-B



POLISHED: ASX-R1760-06
BLACK: ASX-R1760-06-B



POLISHED: ASX-R1760-04
BLACK: ASX-R1760-04-B



POLISHED: ASX-L1770-05
BLACK: ASX-L1770-05-B



POLISHED: ASX-L1770-08
BLACK: ASX-L1770-08-B



POLISHED: ASX-R1776-PR-01
BLACK: ASX-R1776-PR-01-B



POLISHED: ASX-R1760-PR
BLACK: ASX-R1760-PR-B

MITSUBISHI L200

L200- (2006-2009) / L200N- (2009-2015)



POLISHED: L200-R0085 / L200N-R0085
BLACK: L200-R0085-B / L200N-R0085-B



POLISHED: L200-R0070-R / L200N-R0070-R
BLACK: L200-R0070-R-B / L200N-R0070-R-B



POLISHED: L200-R0076-PR-01 / L200N-R0076-PR-01
BLACK: L200-R0076-PR-01-B / L200N-R0076-PR-01-B



POLISHED: L200-R0085-PR / L200N-R0085-PR
BLACK: L200-R0085-PR-B / L200N-R0085-PR-B



POLISHED: L200-R0085-PR-03 / L200N-R0085-PR-03
BLACK: L200-R0085-PR-03-B / L200N-R0085-PR-03-B

MITSUBISHI L200

L200- (2006-2009) / L200N- (2009-2015)



POLISHED: L200-R0070-03 / L200N-R0070-03
BLACK: L200-R0070-03-B / L200N-R0070-03-B



POLISHED: L200-R0070-04 / L200N-R0070-04
BLACK: L200-R0070-04-B / L200N-R0070-04-B



POLISHED: L200-R0070-05 / L200N-R0070-05
BLACK: L200-R0070-05-B / L200N-R0070-05-B



POLISHED: L200-R0085-03 / L200N-R0085-03
BLACK: L200-R0085-03-B / L200N-R0085-03-B



POLISHED: L200-R0085-04 / L200N-R0085-04
BLACK: L200-R0085-04-B / L200N-R0085-04-B



POLISHED: L200-R0085-06 / L200N-R0085-06
BLACK: L200-R0085-06-B / L200N-R0085-06-B



POLISHED: L200-R0076-GR / L200N-R0076-GR
BLACK: L200-R0076-GR-B / L200N-R0076-GR-B



POLISHED: L200-R0085-NR-01 / L200N-R0085-NR-01
BLACK: L200-R0085-NR-01-B / L200N-R0085-NR-01-B

MITSUBISHI L200

2015-



POLISHED: L200-R1570-04



POLISHED: L200-R1576-R



POLISHED: L200-R1570-PR-02



POLISHED: L200-R1576-PR-01



POLISHED: L200-R1570-PR

MITSUBISHI L200

2015-



POLISHED: L200-R1570-00



POLISHED: L200-R1570-03



BLACK: L200-R1570-00-B



BLACK: L200-R1570-06-B



POLISHED: L200-R1570-06



POLISHED: L200-L1570-05



BLACK: L200-R1570-04-B



BLACK: L200-R1570-03-B



POLISHED: L200-L1570-08



POLISHED: L200-L1570-07



BLACK: L200-L1570-08-B



BLACK: L200-L1570-05-B



BLACK: L200-L1570-07-B



BLACK: L200-R1576-R-B



BLACK: L200-R1570-PR-02-B

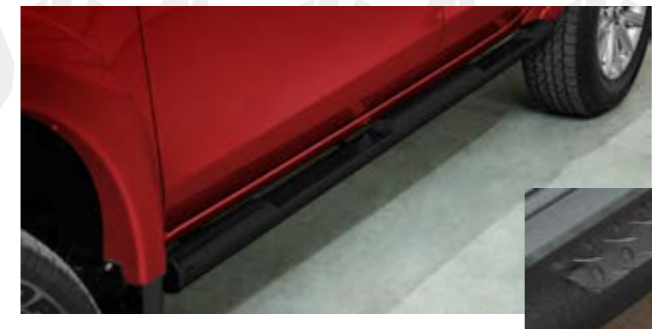

BLACK: L200-R1576-PR-01-B



BLACK: L200-R1570-PR-B

MITSUBISHI OUTLANDER

2007-2010



POLISHED: OT-R0060-04
BLACK: OT-R0060-04-B



POLISHED: OT-R0076-R
BLACK: OT-R0076-R-B

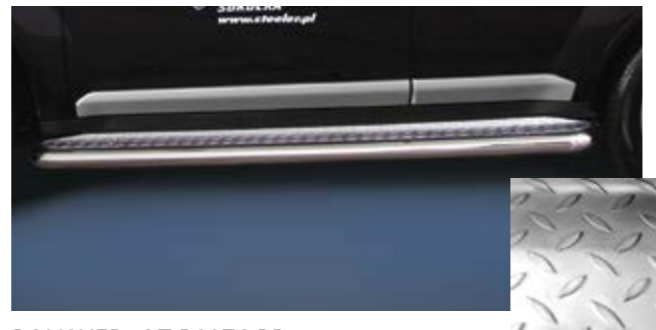

POLISHED: OT-R0076-PR
BLACK: OT-R0076-PR-B



POLISHED:
BLACK: OT-R0076-PR-01



POLISHED:
BLACK: OT-R0076-PR-02



POLISHED: OTN-R0060-06
BLACK: OTN-R0060-06-B



POLISHED: OT-R0060-00
BLACK: OT-R0060-00-B



POLISHED: OT-R0060-03
BLACK: OT-R0060-03-B



POLISHED: OT-R0070-03
BLACK: OT-R0070-03-B



POLISHED: OT-R0070-04
BLACK: OT-R0070-04-B



POLISHED: OT-R0070-05
BLACK: OT-R0070-05-B



POLISHED:
BLACK: OT-R0070-NR



POLISHED:
BLACK: OT-R0070-NR-02

MITSUBISHI OUTLANDER

2010-2012



POLISHED: OTN-R0060-00
BLACK: OTN-R0060-00-B



POLISHED: OTN-R0060-03
BLACK: OTN-R0060-03-B



POLISHED: OTN-R0060-04
BLACK: OTN-R0060-04-B



POLISHED:
BLACK: OTN-R0060-06



POLISHED: OTN-R0070-03
BLACK: OTN-R0070-03-B



POLISHED: OTN-R0070-05
BLACK: OTN-R0070-05-B



POLISHED:
BLACK: OT-R0076-R



POLISHED:
BLACK: OTN-R0076-PR



POLISHED: OTN-R0076-PR-01
BLACK: OTN-R0076-PR-01-B



POLISHED: OTN-R0076-PR-02
BLACK: OTN-R0076-PR-02-B



POLISHED: OTN-R0070-NR
BLACK: OTN-R0070-NR-B



POLISHED: OTN-R0070-NR-02
BLACK: OTN-R0070-NR-02-B

MITSUBISHI OUTLANDER

2012-2015



POLISHED: OT-R1270-04
BLACK: OT-R1270-04-B



POLISHED: OT-R1270
BLACK: OT-R1270-B



POLISHED: OT-R1270-03
BLACK: OT-R1270-03-B



POLISHED: OT-R1276-04
BLACK: OT-R1276-04-B



POLISHED: OT-R1276-05
BLACK: OT-R1276-05-B



POLISHED: OT-R1276-03
BLACK: OT-R1276-03-B



POLISHED: OT-R1276-R
BLACK: OT-R1276-R-B



POLISHED: OT-R1276-PR-01
BLACK: OT-R1276-PR-01-B



POLISHED: OT-R1270-PR-02
BLACK: OT-R1270-PR-02-B



POLISHED: OT-R1276-NR-01
BLACK: OT-R1276-NR-01-B



POLISHED: OT-R1276-NR
BLACK: OT-R1276-NR-B

MITSUBISHI OUTLANDER 2015-



POLISHED: OT-R1570-00
BLACK: OT-R1570-00-B



POLISHED: OT-R1570-04
BLACK: OT-R1570-04-B



POLISHED: OT-R1570-03
BLACK: OT-R1570-03-B



POLISHED: OT-L1570-05
BLACK: OT-L1570-05-B



POLISHED: OT-L1570-08
BLACK: OT-L1570-08-B



POLISHED: OT-R1548-NR-02
BLACK: OT-R1548-NR-02-B



POLISHED: OT-R1570-NR
BLACK: OT-R1570-NR-B

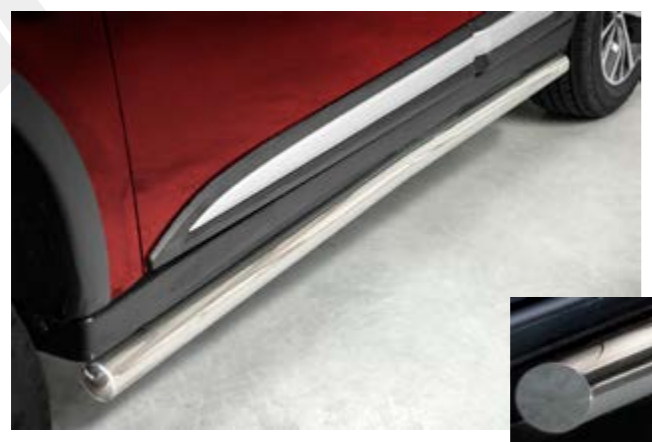

POLISHED: OT-R1560-R
BLACK: OT-R1560-R-B



POLISHED: OT-R1580-PR-04
BLACK: OT-R1580-PR-04-B



POLISHED: OT-R1570-PR-02
BLACK: OT-R1570-PR-02-B

MITSUBISHI PAJERO

2007-2014



POLISHED: PAJERO-R0070-00
BLACK: PAJERO-R0070-00-B



POLISHED: PAJERO-R0070-03
BLACK: PAJERO-R0070-03-B



POLISHED: PAJERO-R0070-04
BLACK: PAJERO-R0070-04-B



POLISHED: PAJERO-R0076-03
BLACK: PAJERO-R0076-03-B



POLISHED: PAJERO-R0076-04
BLACK: PAJERO-R0076-04-B



POLISHED: PAJERO-R0076-06
BLACK: PAJERO-R0076-06-B



POLISHED: PAJERO-R0048-R
BLACK: PAJERO-R0048-R-B



POLISHED: PAJERO-R0070-PR
BLACK: PAJERO-R0070-PR-B



POLISHED: PAJERO-R0070-NR
BLACK: PAJERO-R0070-NR-B

MITSUBISHI PAJERO

2014-



POLISHED: PAJERO-R0070-00
BLACK: PAJERO-R0070-00-B



POLISHED: PAJERO-R0070-04
BLACK: PAJERO-R0070-04-B



POLISHED: PAJERO-R0070-03
BLACK: PAJERO-R0070-03-B



POLISHED: PAJERO-R0070-06
BLACK: PAJERO-R0070-06-B



POLISHED: PAJERO-R1476-03
BLACK: PAJERO-R1476-03-B



POLISHED: PAJERO-R1476-06
BLACK: PAJERO-R1476-06-B



POLISHED: PAJERO-R1476-04
BLACK: PAJERO-R1476-04-B

POLISHED: PAJERO-R1470-NR
BLACK: PAJERO-R1470-NR-B



POLISHED: PAJERO-R0070-PR
BLACK: PAJERO-R0070-PR-B



POLISHED: PAJERO-R0070-PR-03
BLACK: PAJERO-R0070-PR-03-B

NISSAN JUKE

2010-2014



POLISHED: JUKE-R1060-04
BLACK: JUKE-R1060-04-B



POLISHED: JUKE-R1060-03
BLACK: JUKE-R1060-03-B



POLISHED: JUKE-R1070-05
BLACK: JUKE-R1070-05-B



POLISHED: JUKE-R1048-NR
BLACK: JUKE-R1048-NR-B

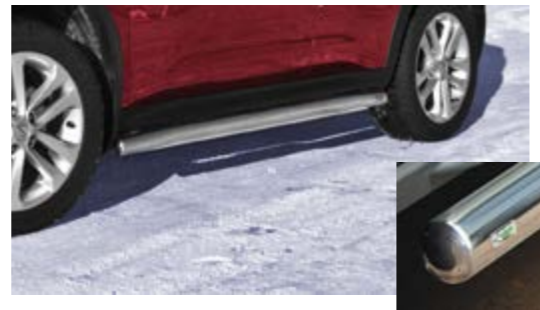

POLISHED: JUKE-R1060-R
BLACK: JUKE-R1060-R-B



POLISHED: JUKE-R1076-PR-01
BLACK: JUKE-R1076-PR-01-B



POLISHED: JUKE-R1070-PR-02
BLACK: JUKE-R1070-PR-02-B

NISSAN NAVARA

D40- (2005-2010) / D40N- (2010-2015)



POLISHED: D40-R0085-00 / D40N-R0085-00 / D40N-R0085-00-V6
BLACK: D40-R0085-00-B / D40N-R0085-00-B / D40N-R0085-00-V6-B



POLISHED: D40-R0085-PR / D40N-R0085-PR
BLACK: D40-R0085-PR-B / D40N-R0085-PR-B



POLISHED: D40-R0085-NR-01 / D40N-R0085-NR-01
BLACK: D40-R0085-NR-01-B / D40N-R0085-NR-01-B



POLISHED: D40-R0076-GR / D40N-R0076-GR
BLACK: D40-R0076-GR-B / D40N-R0076-GR-B

NISSAN NAVARA

D40- (2005-2010) / D40N- (2010-2015)



POLISHED:
D40-R0085-03 / D40N-R0085-03 / D40N-R0085-03-V6
BLACK:
D40-R0085-03-B / D40N-R0085-03-B / D40N-R0085-03-V6-B



POLISHED:
D40-R0085-04 / D40N-R0085-04 / D40N-R0085-04-V6
BLACK:
D40-R0085-04-B / D40N-R0085-04-B / D40N-R0085-04-V6-B



POLISHED:
D40-R0085-06 / D40N-R0085-06 / D40N-R0085-06-V6
BLACK:
D40-R0085-06-B / D40N-R0085-06-B / D40N-R0085-06-V6-B



POLISHED: D40-R0085-05 / D40N-R0085-05
BLACK: D40-R0085-05-B / D40N-R0085-05-B

POLISHED: D40-R0076-GR-01 / D40N-R0076-GR-01
BLACK: D40-R0076-GR-01-B / D40N-R0076-GR-01-B



NISSAN NAVARA NP300

2015-



POLISHED: NP300-L1570-08



POLISHED: NP300-R1548-R



POLISHED: NP300-R1576-PR-01



POLISHED: NP300-R1570-PR-02



POLISHED: NP300-R1570-PR

NISSAN NAVARA NP300 2015-



POLISHED: NP300-R1570-00



POLISHED: NP300-R1570-04



BLACK: NP300-R1570-00-B



BLACK: NP300-R1570-04-B



POLISHED: NP300-R1570-03



POLISHED: NP300-R1570-06



BLACK: NP300-R1570-03-B



BLACK: NP300-R1570-06-B



POLISHED: NP300-L1570-05



BLACK: NP300-L1570-05-B



BLACK: NP300-L1570-08-B



BLACK: NP300-R1548-R-B



BLACK: NP300-R1576-PR-01-B



BLACK: NP300-R1570-PR-02-B



BLACK: NP300-R1570-PR-B



POLISHED: NP300-R1576-GR
BLACK: NP300-R1576-GR-B

POLISHED: NP300-L1570-NR-01
BLACK: NP300-L1570-NR-01-B

NISSAN PATHFINDER

PATH- (2005-2010) / PATHN- (2010-)



POLISHED:
PATH-R0085-00 / PATHN-R0085-00 / PATHN-R0085-V6
BLACK:
PATH-R0085-00-B / PATHN-R0085-00-B / PATHN-R0085-V6-B



POLISHED:
PATH-R0085-03 / PATHN-R0085-03 / PATHN-R0085-03-V6
BLACK:
PATH-R0085-03-B/PATHN-R0085-03-B/ PATHN-R0085-03-V6-B



POLISHED:
PATH-R0085-04 / PATHN-R0085-04 / PATHN-R0085-04-V6
BLACK:
PATH-R0085-04-B/PATHN-R0085-04-B/PATHN-R0085-04-V6-B



POLISHED:
PATH-R0085-06 / PATHN-R0085-06 / PATHN-R0085-06-V6
BLACK:
PATH-R0085-06-B/PATHN-R0085-06-B/PATHN-R0085-06-V6-B



POLISHED: PATH-R0085-05 / PATHN-R0085-05
BLACK: PATH-R0085-05-B / PATHN-R0085-05-B



POLISHED: PATH-R0048-R / PATHN-R0048-R
BLACK: PATH-R0048-R-B / PATHN-R0048-R-B



POLISHED: PATH-R0085-NR-01 / PATHN-R0085-NR-01
BLACK: PATH-R0085-NR-01-B / PATHN-R0085-NR-01-B



POLISHED: PATH-R0085-PR / PATHN-R0085-PR
BLACK: PATH-R0085-PR-B / PATHN-R0085-PR-B

NISSAN QASHQAI

2007-2010



POLISHED: QUA-R0060-00
BLACK: QUA-R0060-00-B



POLISHED: QUA-R0048-R
BLACK: QUA-R0048-R-B



POLISHED: QUA-R0076-PR
BLACK: QUA-R0076-PR-B



POLISHED: QUA-R0076-PR-01
BLACK: QUA-R0076-PR-01-B



POLISHED: QUA-R0076-PR-02
BLACK: QUA-R0076-PR-02-B

NISSAN QASHQAI

2007-2010



POLISHED: QUA-R0060-03
BLACK: QUA-R0060-03-B



POLISHED: QUA-R0060-04
BLACK: QUA-R0060-04-B



POLISHED: QUA-R0060-06
BLACK: QUA-R0060-06-B



POLISHED: QUA-R0070-03
BLACK: QUA-R0070-03-B



POLISHED: QUA-R0070-04
BLACK: QUA-R0070-04-B



POLISHED: QUA-R0076-NR
BLACK: QUA-R0076-NR-B

NISSAN QASHQAI

2010-2013



POLISHED: QUAN-R0060-00
BLACK: QUAN-R0060-00-B



POLISHED: QUAN-R0048-R / QUAN+2-R0048-R
BLACK: QUAN-R0048-R-B / QUAN+2-R0048-R-B



POLISHED: QUAN-R0076-PR / QUAN+2-R0076-PR
BLACK: QUAN-R0076-PR-B / QUAN+2-R0076-PR-B



POLISHED: QUAN-R0076-PR-01 / QUAN+2-R0076-PR-01
BLACK: QUAN-R0076-PR-01-B / QUAN+2-R0076-PR-01-B



POLISHED: QUAN-R0076-PR-02 / QUAN+2-R0076-PR-02
BLACK: QUAN-R0076-PR-02-B / QUAN+2-R0076-PR-02-B

NISSAN QASHQAI

2010-2013



POLISHED: QUAN-R0060-03
BLACK: QUAN-R0060-03-B



POLISHED: QUAN-R0060-04
BLACK: QUAN-R0060-04-B



POLISHED: QUAN-R0060-06
BLACK: QUAN-R0060-06-B



POLISHED: QUAN-R0070-03
BLACK: QUAN-R0070-03 -B



POLISHED: QUAN-R0070-04
BLACK: QUAN-R0070-04-B

POLISHED: QUAN-R0076-NR / QUAN+2-R0076-NR
BLACK: QUAN-R0076-NR-B / QUAN+2-R0076-NR-B



NISSAN QASHQAI

2013-2017



POLISHED: QUA-L1360-08
BLACK: QUA-L1360-08-B



POLISHED: QUA-R1360-R
BLACK: QUA-R1360-R-B



POLISHED: QUA-R1360-PR
BLACK: QUA-R1360-PR-B



POLISHED: QUA-R1376-PR-01
BLACK: QUA-R1376-PR-01-B



POLISHED: QUA-R1370-PR-02
BLACK: QUA-R1370-PR-02-B

NISSAN QASHQAI

2013-2017



POLISHED: QUA-R1360
BLACK: QUA-R1360-B



POLISHED: QUA-R1360-03
BLACK: QUA-R1360-03



POLISHED: QUA-R1360-04
BLACK: QUA-R1360-04-B



POLISHED: QUA-L1360-05
BLACK: QUA-L1360-05-B



POLISHED: QUA-R1360-06
BLACK: QUA-R1360-06-B



POLISHED: QUA-R1360-NR
BLACK: QUA-R1360-NR-B

NISSAN QASHQAI

2017-



POLISHED: QUA-L1760-08
BLACK: QUA-L1760-08 -B



POLISHED: QUA-R1776-PR-01
BLACK: QUA-R1776-PR-01-B



POLISHED: QUA-R1770-PR-02
BLACK: QUA-R1770-PR-02-B

NISSAN QASHQAI

2017-



POLISHED: QUA-R1770-06
BLACK: QUA-R1770-06-B



POLISHED: QUA-L1760-S
BLACK: QUA-L1760-S-B



POLISHED: QUA-L1760-05
BLACK: QUA-L1760-05-B



POLISHED: QUA-R1760-R
BLACK: QUA-R1760-R-B

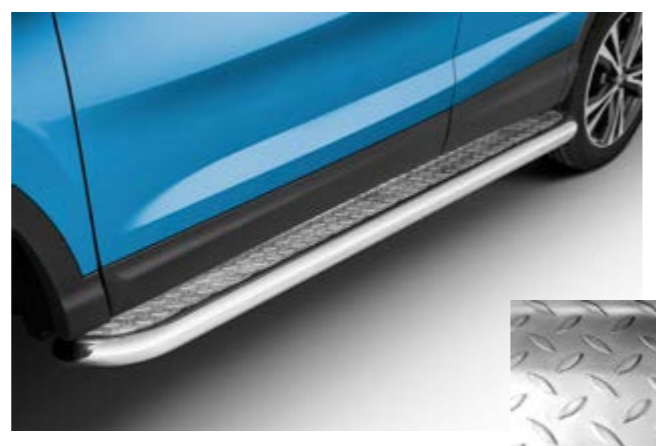

POLISHED: QUA-R1760-PR
BLACK: QUA-R1760-PR-B

NISSAN X-TRAIL

R-00 (2007-2010) / R-10 (2010-2012-)



POLISHED: X-TRAIL-R0076-06 / X-TRAIL-R1076-06
BLACK: X-TRAIL-R0076-06-B / X-TRAIL-R1076-06-B



POLISHED: X-TRAIL-R0070-R / X-TRAIL-R1070-R
BLACK: X-TRAIL-R0070-R-B / X-TRAIL-R1070-R-B



POLISHED: X-TRAIL-R0070-PR / X-TRAIL-R1070-PR
BLACK: X-TRAIL-R0070-PR-B / X-TRAIL-R1070-PR-B



POLISHED: X-TRAIL-R0070-PR-01 / X-TRAIL-R1070-PR-01
BLACK: X-TRAIL-R0070-PR-01-B / X-TRAIL-R1070-PR-01-B



POLISHED:
BLACK: X-TRAIL-R0070-PR-02 / X-TRAIL-R1070-PR-02

NISSAN X-TRAIL

R-00 (2007-2010) / R-10 (2010-2012-)



POLISHED: X-TRAIL-R0070 / X-TRAIL-R1070
BLACK: X-TRAIL-R0070-B / X-TRAIL-R1070-B



POLISHED: X-TRAIL-R0070-03 / X-TRAIL-R1070-03
BLACK: X-TRAIL-R0070-03-B / X-TRAIL-R1070-03-B



POLISHED: X-TRAIL-R0070-04 / X-TRAIL-R1070-04
BLACK: X-TRAIL-R0070-04-B / X-TRAIL-R1070-04-B



POLISHED: X-TRAIL-R0070-06 / X-TRAIL-R1070-06
BLACK: X-TRAIL-R0070-06-B / X-TRAIL-R1070-06-B



POLISHED: X-TRAIL-R0076-03 / X-TRAIL-R1076-03
BLACK: X-TRAIL-R0076-03-B / X-TRAIL-R1076-03-B



POLISHED: X-TRAIL-R0076-04 / X-TRAIL-R1076-04
BLACK: X-TRAIL-R0076-04-B / X-TRAIL-R1076-04-B



POLISHED: X-TRAIL-R0070-NR / X-TRAIL-R1070-NR
BLACK: X-TRAIL-R0070-NR-B / X-TRAIL-R1070-NR-B

NISSAN X-TRAIL

2014-2017



POLISHED: X-TRAIL-R1470
BLACK: X-TRAIL-R1470-B

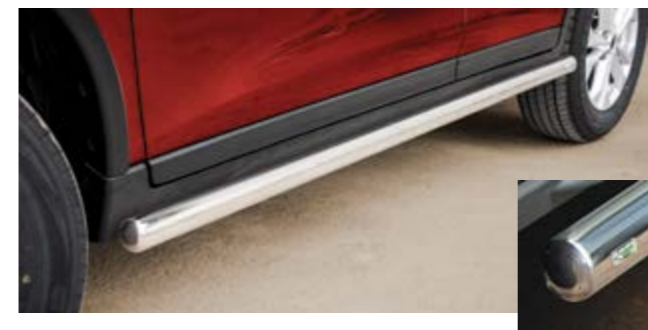

POLISHED: X-TRAIL-R1460-R
BLACK: X-TRAIL-R1460-R-B



POLISHED: X-TRAIL-R1476-PR-01
BLACK: X-TRAIL-R1476-PR-01-B



POLISHED: X-TRAIL-R1470-PR-02
BLACK: X-TRAIL-R1470-PR-02-B

NISSAN X-TRAIL

2014-2017



POLISHED: X-TRAIL-R1470-03
BLACK: X-TRAIL-R1470-03-B



POLISHED: X-TRAIL-R1470-04
BLACK: X-TRAIL-R1470-04-B



POLISHED: X-TRAIL-R1470-06
BLACK: X-TRAIL-R1470-06-B



POLISHED: X-TRAIL-R1470-NR
BLACK: X-TRAIL-R1470-NR-B

OPEL CROSSLAND X

2017-



POLISHED: CROSSLAND-L1660-08
BLACK: CROSSLAND-L1660-08-B



POLISHED: CROSSLAND-R1660-R
BLACK: CROSSLAND-R1660-R -B



POLISHED: CROSSLAND-L1660-05
BLACK: CROSSLAND-L1660-05-B



POLISHED: CROSSLAND-R1676-PR-01
BLACK: CROSSLAND-R1676-PR-01 -B



POLISHED: CROSSLAND-R1670-PR-02
BLACK: CROSSLAND-R1670-PR-02-B

OPEL VIVARO 2014-



POLISHED: RON-R1460-00
BLACK: RON-R1460-00-B



POLISHED: RON-R1460-03
BLACK: RON-R1460-03-B



POLISHED: RON-R1460-06
BLACK: RON-R1460-06-B



POLISHED: RON-R1460-04
BLACK: RON-R1460-04-B



POLISHED: RON-R1470-R
BLACK: RON-R1470-R -B



POLISHED: RON-R1470-PR-02
BLACK: RON-R1470-PR-02-B



POLISHED: RON-R1476-PR-01
BLACK: RON-R1476-PR-01-B

REANULT KADJAR 2016-



POLISHED: KADJAR-N1560-09
BLACK: KADJAR-N1560-09-B



POLISHED: KADJAR-L1560-05
BLACK: KADJAR-L1560-05-B



POLISHED: KADJAR-L1560-08
BLACK: KADJAR-L1560-08-B

POLISHED: KADJAR-N1560-10
BLACK: KADJAR-N1560-10-B



POLISHED: KADJAR-R1560-R
BLACK: KADJAR-R1560-R-B



POLISHED: KADJAR-R1570-PR-02
BLACK: KADJAR-R1570-PR-02-B



POLISHED: KADJAR-R1576-PR-01
BLACK: KADJAR-R1576-PR-01-B



REANULT MASTER 2010-

POLISHED: MASTER-R1070
BLACK: MASTER-R1070-B



POLISHED: MASTER-R1070-03
BLACK: MASTER-R1070-03-B



POLISHED: MASTER-R1070-04
BLACK: MASTER-R1070-04-B



POLISHED: MASTER-R1070-R
BLACK: MASTER-R1070-R-B



POLISHED: MASTER-R1076-PR-01
BLACK: MASTER-R1076-PR-01-B



POLISHED: MASTER-R1070-PR-02
BLACK: MASTER-R1070-PR-02-B

SEAT ATECA 2016-



POLISHED: ATECA-L1660-08
BLACK: ATECA-L1660-08-B



POLISHED: ATECA-R1660-R
BLACK: ATECA-R1660-R-B



POLISHED: ATECA-R1670-PR-02
BLACK: ATECA-R1670-PR-02-B

SEAT ATECA 2016-



POLISHED: ATECA-N1660-09
BLACK: ATECA-N1660-09-B



POLISHED: ATECA-N1660-10
BLACK: ATECA-N1660-10-B



POLISHED: ATECA-L1660-05
BLACK: ATECA-L1660-05-B



POLISHED: ATECA-L1660-07
BLACK: ATECA-L1660-07-B



POLISHED: ATECA-R1676-PR-01
BLACK: ATECA-R1676-PR-01-B

SKODA KODIAQ 2016-



POLISHED: KODIAQ-R1660-04
BLACK: KODIAQ-R1660-04-B

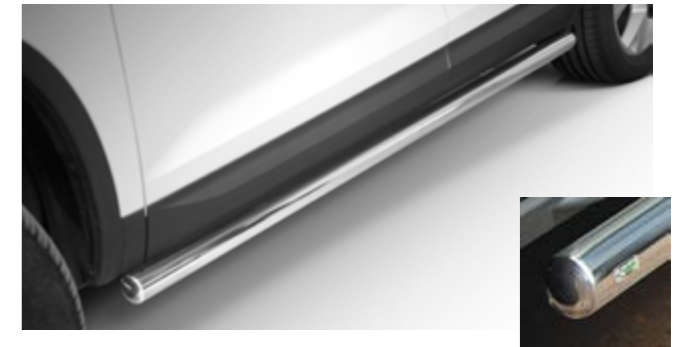

POLISHED: KODIAQ-R1660-R
BLACK: KODIAQ-R1660-R-B



POLISHED: KODIAQ-R1676-PR-01
BLACK: KODIAQ-R1676-PR-01-B

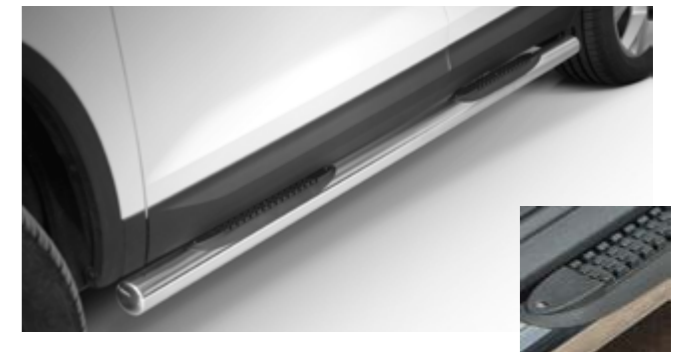

POLISHED: KODIAQ-R1670-PR-02
BLACK: KODIAQ-R1670-PR-02-B

SKODA KODIAQ

2016-



POLISHED: KODIAQ-R1660-03
BLACK: KODIAQ-R1660-03-B



POLISHED: KODIAQ-R1660-06
BLACK: KODIAQ-R1660-06-B



POLISHED: KODIAQ-R1660-00
BLACK: KODIAQ-R1660-00-B



POLISHED: KODIAQ-L1660-05
BLACK: KODIAQ-L1660-05-B



POLISHED: KODIAQ-L1660-08
BLACK: KODIAQ-L1660-08-B



POLISHED: KODIAQ-N1660-09
BLACK: KODIAQ-N1660-09-B



POLISHED: KODIAQ-N1660-10
BLACK: KODIAQ-N1660-10-B

SUBARU FORESTER

2008-2012



POLISHED: FORESTER-R0070
BLACK: FORESTER-R0070-B



POLISHED: FORESTER-R0060-R
BLACK: FORESTER-R0060-R-B



POLISHED: FORESTER-R0076-PR-01
BLACK: FORESTER-R0076-PR-01-B



POLISHED: FORESTER-R0070-PR-02
BLACK: FORESTER-R0070-PR-02-B

SUBARU FORESTER

2008-2012

SUBARU FORESTER

2013-2016



POLISHED: FORESTER-R0070-03
BLACK: FORESTER-R0070-03-B



POLISHED: FORESTER-R0070-04
BLACK: FORESTER-R0070-04-B



POLISHED: FORESTER-R0070-05
BLACK: FORESTER-R0070-05-B



POLISHED: FORESTER-R0070-07
BLACK: FORESTER-R0070-07-B



POLISHED: FORESTER-R0070-08
BLACK: FORESTER-R0070-08-B



POLISHED: FORESTER-R0070-NR
BLACK: FORESTER-R0070-NR-B



POLISHED: FORESTER-R1370-04
BLACK: FORESTER-R1370-04-B



POLISHED: FORESTER-R1360-R
BLACK: FORESTER-R1360-R-B



POLISHED: FORESTER-R1360-PR
BLACK: FORESTER-R1360-PR-B



POLISHED: FORESTER-R1376-PR-01
BLACK: FORESTER-R1376-PR-01-B



POLISHED: FORESTER-R1370-PR-02
BLACK: FORESTER-R1370-PR-02-B

SUBARU FORESTER

2013-2016



POLISHED: FORESTER-R1370
BLACK: FORESTER-R1370-B



POLISHED: FORESTER-R1370-03
BLACK: FORESTER-R1370-03-B



POLISHED: FORESTER-R1370-06
BLACK: FORESTER-R1370-06-B



POLISHED: FORESTER-R1376
BLACK: FORESTER-R1376-B



POLISHED: FORESTER-R1376-04
BLACK: FORESTER-R1376-04-B



POLISHED: FORESTER-R1376-06
BLACK: FORESTER-R1376-06-B

POLISHED: FORESTER-R1348-NR
BLACK: FORESTER-R1348-NR-B



SUBARU FORESTER

2016-



POLISHED: FORESTER-R1376-04
BLACK: FORESTER-R1376-04-B



POLISHED: FORESTER-R1360-R
BLACK: FORESTER-R1360-R-B



POLISHED: FORESTER-R1360-PR
BLACK: FORESTER-R1360-PR-B



POLISHED: FORESTER-R1376-PR-01
BLACK: FORESTER-R1376-PR-01-B



POLISHED: FORESTER-R1370-PR-02
BLACK: FORESTER-R1370-PR-02-B

SUBARU FORESTER

2016-



POLISHED: FORESTER-R1370-03
BLACK: FORESTER-R1370-03-B



POLISHED: FORESTER-R1370-06
BLACK: FORESTER-R1370-06-B



POLISHED: FORESTER-R1370
BLACK: FORESTER-R1370-B



POLISHED: FORESTER-R1376-06
BLACK: FORESTER-R1376-06-B



POLISHED: FORESTER-R1376
BLACK: FORESTER-R1376-B



POLISHED: FORESTER-R1360-R
BLACK: FORESTER-R1360-R-B



POLISHED: FORESTER-R1360-PR
BLACK: FORESTER-R1360-PR-B

SUZUKI GRAND VITARA

2006-2015



POLISHED: VITARA-R0076-00
BLACK: VITARA-R0076-00-B



POLISHED: VITARA-R0076-R
BLACK: VITARA-R0076-R-B



POLISHED: VITARA-R0076-PR-01
BLACK: VITARA-R0076-PR-01-B



POLISHED: VITARA-R0076-PR-02
BLACK: VITARA-R0076-PR-02-B



POLISHED: VITARA-R0076-PR-03
BLACK: VITARA-R0076-PR-03-B

SUZUKI GRAND VITARA

2006-2015

SUZUKI JIMNY

2005-2012



POLISHED: VITARA-R0070-03
BLACK: VITARA-R0070-03-B



POLISHED: VITARA-R0070-04
BLACK: VITARA-R0070-04-B



POLISHED: VITARA-R0070-06
BLACK: VITARA-R0070-06-B



POLISHED: VITARA-R0076-03
BLACK: VITARA-R0076-03-B



POLISHED: VITARA-R0076-04
BLACK: VITARA-R0076-04-B



POLISHED: VITARA-R0076-06
BLACK: VITARA-R0076-06-B



POLISHED: VITARA-R0076-NR-01
BLACK: VITARA-R0076-NR-01-B



POLISHED: JIMNY-R0070-04
BLACK: JIMNY-R0070-04-B



POLISHED: JIMNY-R0070-R
BLACK: JIMNY-R0070-R-B



POLISHED: JIMNY-R0070-PR
BLACK: JIMNY-R0070-PR-B

SUZUKI JIMNY

2005-2012



POLISHED: JIMNY-R0070
BLACK: JIMNY-R0070-B



POLISHED: JIMNY-R0070-03
BLACK: JIMNY-R0070-03-B



POLISHED: JIMNY-R0070-06
BLACK: JIMNY-R0070-06-B



POLISHED: JIMNY-R0076-04
BLACK: JIMNY-R0076-04-B



POLISHED: JIMNY-R0076-06
BLACK: JIMNY-R0076-06-B



POLISHED: JIMNY-R0076-PR-01
BLACK: JIMNY-R0076-PR-01-B



POLISHED: JIMNY-R0070-PR-02
BLACK: JIMNY-R0070-PR-02-B

SUZUKI JIMNY

2012-2018



POLISHED: JIMNY-R1270-00
BLACK: JIMNY-R1270-00-B



POLISHED: JIMNY-R1270-R
BLACK: JIMNY-R1270-R-B



POLISHED: JIMNY-R1276-PR-01
BLACK: JIMNY-R1276-PR-01-B



POLISHED: JIMNY-R1270-PR-02
BLACK: JIMNY-R1270-PR-02-B

SUZUKI JIMNY

2012-2018



POLISHED: JIMNY-R1270-03
BLACK: JIMNY-R1270-03-B



POLISHED: JIMNY-R1270-04
BLACK: JIMNY-R1270-04-B



POLISHED: JIMNY-R1270-06
BLACK: JIMNY-R1270-06-B



POLISHED: JIMNY-R1276-03
BLACK: JIMNY-R1276-03-B



POLISHED: JIMNY-R1276-04
BLACK: JIMNY-R1276-04-B



POLISHED: JIMNY-R1276-06
BLACK: JIMNY-R1276-06-B



POLISHED: JIMNY-R1270-PR
BLACK: JIMNY-R1270-PR-B



POLISHED: JIMNY-R1270-PR-03
BLACK: JIMNY-R1270-PR-03-B

SUZUKI SX4

2006-2013



POLISHED: SX4-R0060-04
BLACK: SX4-R0060-04-B



POLISHED: SX4-R0060-03
BLACK: SX4-R0060-03-B



POLISHED: SX4-R0070-04
BLACK: SX4-R0070-04-B



POLISHED: SX4-R0070-06
BLACK: SX4-R0070-06-B



POLISHED: SX4-R0060-R
BLACK: SX4-R0060-R-B



POLISHED: SX4-R0070-PR-02
BLACK: SX4-R0070-PR-02-B



POLISHED: SX4-R0076-PR-01
BLACK: SX4-R0076-PR-01-B

SUZUKI SX4 S-CROSS

2013-2016



POLISHED: S-CROSS-R1360
BLACK: S-CROSS-R1360-B



POLISHED: S-CROSS-R1360-03
BLACK: S-CROSS-R1360-03-B



POLISHED: S-CROSS-R1360-04
BLACK: S-CROSS-R1360-04-B



POLISHED: S-CROSS-R1360-05
BLACK: S-CROSS-R1360-05-B

POLISHED: S-CROSS-R1360-08
BLACK: S-CROSS-R1360-08-B



POLISHED: S-CROSS-R1360-R
BLACK: S-CROSS-R1360-R-B



POLISHED: S-CROSS-R1376-PR-01
BLACK: S-CROSS-R1376-PR-01-B



POLISHED: S-CROSS-R1370-PR-02
BLACK: S-CROSS-R1370-PR-02-B

SUZUKI SX4 S-CROSS

2016-



POLISHED: S-CROSS-R1660-00
BLACK: S-CROSS-R1660-00 -B



POLISHED: S-CROSS-R1660-03
BLACK: S-CROSS-R1660-03 -B



POLISHED: S-CROSS-R1660-06
BLACK: S-CROSS-R1660-06 -B



POLISHED: S-CROSS-R1660-04
BLACK: S-CROSS-R1660-04 -B



POLISHED: S-CROSS-L1660-05
BLACK: S-CROSS-L1660-05 -B



POLISHED: S-CROSS-L1660-08
BLACK: S-CROSS-L1660-08 -B



POLISHED: S-CROSS-R1660-R
BLACK: S-CROSS-R1660-R -B



POLISHED: S-CROSS-R1676-PR-01
BLACK: S-CROSS-R1676-PR-01 -B



POLISHED: S-CROSS-R1670-PR-02
BLACK: S-CROSS-R1670-PR-02-B

SUZUKI VITARA

2015-



POLISHED: VITARA-R1560-00
BLACK: VITARA-R1560-00-B



POLISHED: VITARA-R1560-03
BLACK: VITARA-R1560-03-B



POLISHED: VITARA-R1560-04
BLACK: VITARA-R1560-04-B



POLISHED: VITARA-R1560-05
BLACK: VITARA-R1560-05-B



POLISHED: VITARA-R1560-08
BLACK: VITARA-R1560-08-B



POLISHED: VITARA-R1560-R
BLACK: VITARA-R1560-R-B



POLISHED: VITARA-R1576-PR-01
BLACK: VITARA-R1576-PR-01-B



POLISHED: VITARA-R1570-PR-02
BLACK: VITARA-R1570-PR-02-B



POLISHED: VITARA-R1548-NR
BLACK: VITARA-R1548-NR -B

TOYOTA HILUX

2005-2011-2015



POLISHED: DKUN-R0085-00
BLACK: DKUN-R0085-00-B



POLISHED: DKUN-R0076-04
BLACK: DKUN-R0076-04-B



POLISHED: DKUN-R0076-05
BLACK: DKUN-R0076-05-B



POLISHED: DKUN-R0076-06
BLACK: DKUN-R0076-06-B



POLISHED: DKUN-R0085-03
BLACK: DKUN-R0085-03-B



POLISHED: DKUN-R0085-04
BLACK: DKUN-R0085-04-B



POLISHED: DKUN-R0085-06
BLACK: DKUN-R0085-06-B



POLISHED: DKUN-R0085-R
BLACK: DKUN-R0085-R-B



POLISHED: DKUN-R0085-PR
BLACK: DKUN-R0085-PR-B



POLISHED: DKUN-R0085-PR-01
BLACK: DKUN-R0085-PR-01-B



POLISHED: DKUN-R0085-PR-02
BLACK: DKUN-R0085-PR-02-B



POLISHED: DKUN-R0076-GR
BLACK: DKUN-R0076-GR-B



POLISHED: DKUN-R0085-NR-01
BLACK: DKUN-R0085-NR-01-B

Toyota Hilux - AT35



AFTER CONVERSION

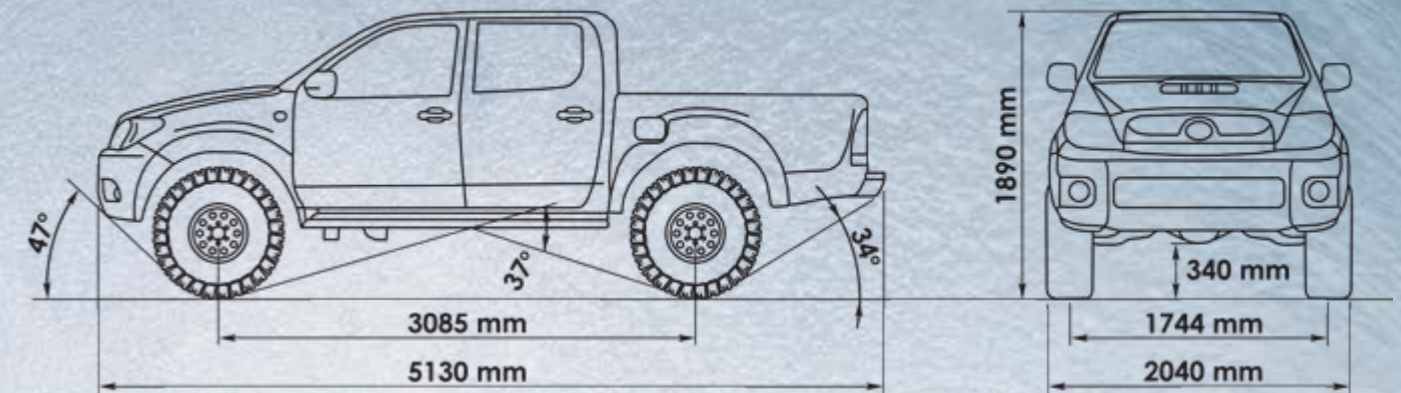

Choose your suspension

Choose your tyres



OE suspension (stock)



BF Goodrich A/T KO2 315/70 R17

Nokian Hakkapeliitta LT 2 315/70 R17

AT35 CONVERSION

The Toyota Hilux AT35 is based on the well known and worldwide Toyota Hilux. In order to fit the larger 315x70 R17 off-road tires the front and rear suspension is lifted 40 mm and the wheel arches are cut up and made larger. Tailor made fender flares are fitted to cover the large tires. The side steps are extended to match the fender flares.

The modifications are design in such a way that the vehicle will keep all its original functions and still get better drivability, both on and off-road. All parts are either genuine Toyota parts or special parts fabricated from high grade material and designed by strict standards.

AT35 CONTENTS

- 315x70 R17" tires BFG AT KO2 or Nokian Hakkapeliitta LT2 „Arctic Trucks”
- 17x10" alloy wheels
- Torque wrench
- Fender flares, painted
- Running boards and brackets
- Mud flaps
- Speedometer calibrator
- 40 mm suspension lift, front/rear
- Fender trimming, front/rear
- First aid kit
- Wheel alignment

Modification cost with OE suspension: 8 950 euro net
Delivery to our location not included.
Stainless steel products and additional lamps are not included.
Lead time: 10 working days.

Contact:
e-mail: info@arctictrucks.pl
phone: +48 85 711 95 58

TOYOTA HILUX 2015-2018



POLISHED: DKUN-R1570-00
BLACK: DKUN-R1570-00-B



POLISHED: DKUN-L1570-05



POLISHED: DKUN-R1570-03



POLISHED: DKUN-L1570-08



POLISHED: DKUN-R1570-06



POLISHED: DKUN-L1570-07



POLISHED: DKUN-R1570-04



POLISHED: DKUN-R1570-R

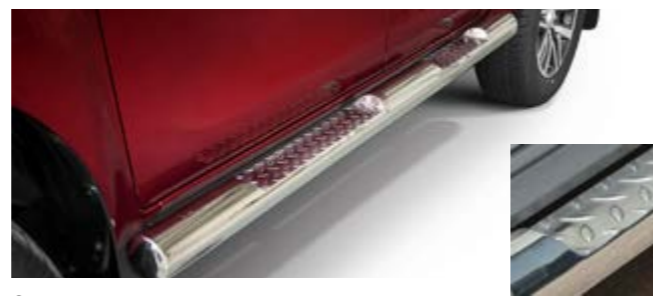

fi 70 POLISHED: DKUN-R1576-PR-01
fi 100 POLISHED: DKUN-R15100-PR-01



BLACK: DKUN-R1570-R-B



fi 70 BLACK: DKUN-R1576-PR-01-B
fi 100 BLACK: DKUN-R15100-PR-01-B



POLISHED: DKUN-R1570-PR-02



POLISHED: DKUN-R1570-PR



BLACK: DKUN-R1570-PR-02-B



BLACK: DKUN-R1570-PR-B

TOYOTA HILUX 2015-2018



BLACK: DKUN-L1570-05-B



BLACK: DKUN-L1570-08-B



BLACK: DKUN-L1570-07-B



BLACK: DKUN-R1570-03-B



BLACK: DKUN-R1570-06-B



BLACK: DKUN-R1570-04-B



POLISHED: DKUN-R1570-GR
BLACK: DKUN-R1570-GR-B



POLISHED: DKUN-R1576-GR
BLACK: DKUN-R1576-GR-B



POLISHED: DKUN-R1576-2GR
BLACK: DKUN-R1576-2GR-B

TOYOTA HILUX 2018-



POLISHED: DKUN-R1870-04

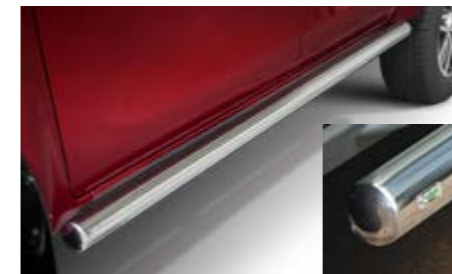

POLISHED: DKUN-R1570-PR-02



POLISHED fi70: DKUN-R1576-PR-01

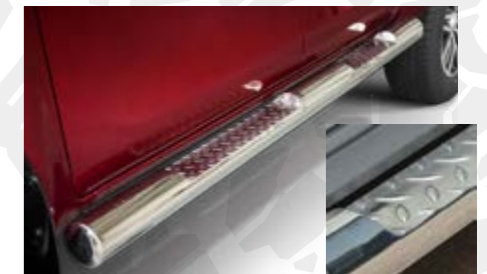

POLISHED fi100: DKUN-R15100-PR-01



POLISHED: DKUN-R1570-PR-05



POLISHED: DKUN-R1570-PR-02

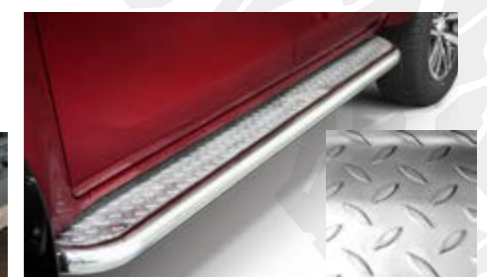

POLISHED: DKUN-R1570-PR

TOYOTA HILUX 2018-



POLISHED: DKUN-R1870-03



POLISHED: DKUN-L1870-05



BLACK: DKUN-R1870-03-B



BLACK: DKUN-L1870-05-B



POLISHED: DKUN-R1870-00



POLISHED: DKUN-L1870-08



BLACK: DKUN-R1870-00-B



BLACK: DKUN-L1870-08-B



POLISHED fi70: DKUN-R1870-06



POLISHED: DKUN-L1870-07



BLACK: DKUN-R1870-06-B



BLACK: DKUN-L1870-07-B



POLISHED fi76: DKUN-R1876-06



BLACK fi76: DKUN-R1876-06-B



BLACK: DKUN-L1570-08-B



BLACK: DKUN-R1570-PR-02-B



BLACK fi70: DKUN-R1576-PR-01-B



BLACK fi100: DKUN-R15100-PR-01-B



POLISHED: DKUN-R1570-GR
BLACK: DKUN-R1570-GR-B



BLACK: DKUN-R1570-PR-02-B



BLACK: DKUN-R1570-PR-02-B



BLACK: DKUN-R1570-PR-B



POLISHED: DKUN-R1576-GR
BLACK: DKUN-R1576-GR-B



POLISHED: DKUN-R1576-2GR
BLACK: DKUN-R1576-2GR-B

Toyota Hilux / Hilux Revo - AT35



AFTER CONVERSION

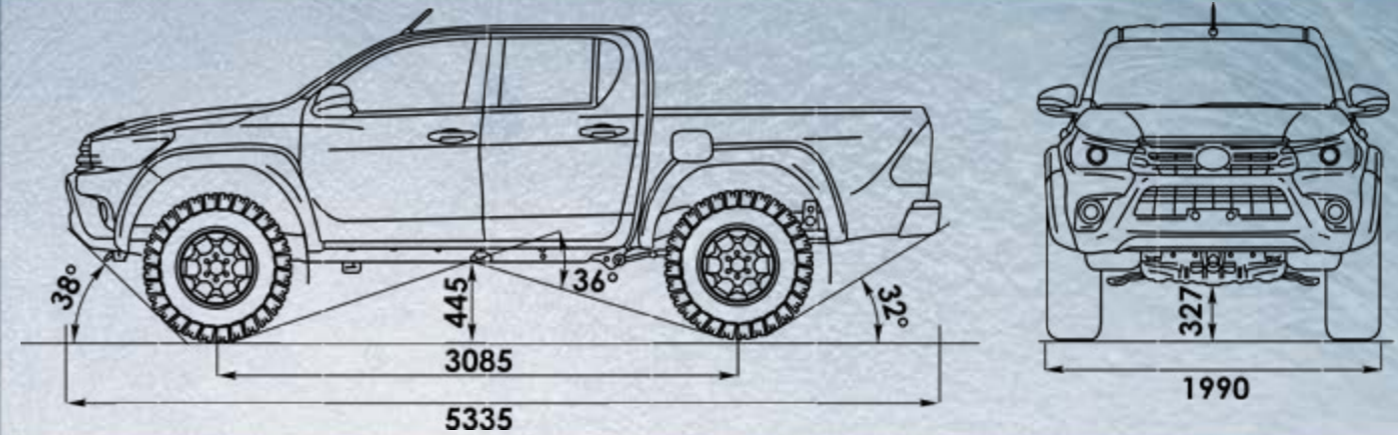

Choose your Suspension

Choose your tyres



OE suspension (stock)

OME BP-51 suspension



BF Goodrich A/T KO2 315/70 R17

Nokian Hakkapelita LT 2 315/70 R17

When we convert a PICK-UP to 35" tires, we lift the suspension 40 mm, and in some cases we would lift both the suspension and the body. Extra fender flares are used which gives your SUV a powerful look and separates it from all others. With the AT35 you can take your PICK-UP to almost any mountain road in the world, with out having any trouble.

The AT35 will give you much grater ground clearance, better traction, softer ride, higher seating and most of all a feeling of confidence. Also will it give you the possibility to deflate your tires, so that you get a better flotation in snow, sand and mud.

The AT35 is ideal for hunters, farmers and park rangers, or just for those who want something different from the rest.

- 315x70 R17" AT tires
- 17x10" alloy wheels
- Torque wrench
- Fender flares, painted
- Running boards and brackets
- Mud flaps
- Speedometer calibrator
- 40 mm suspension lift, front

Modification cost with OE suspension: 8 950 euro net
 Delivery to our location not included.
 Stainless steel products and additional lamps are not included.
 Lead time: 15 working days.
 Payment: 10% with the order 90% before car pick up.

Contact:
 e-mail: info@arctictrucks.pl
 phone: +48 85 711 95 58



STEELER
 ul. Grodzienska 206
 16-100 Sokolka
 Poland
 NIP: 545-161-39-48
www.arctictrucks.pl

TOYOTA LAND CRUISER 120

2003-2009



POLISHED: DLC120-R0076-06
BLACK: DLC120-R0076-06-B



POLISHED: DLC120-R0076-04
BLACK: DLC120-R0076-04-B



POLISHED: DLC120-R0085-05
BLACK: DLC120-R0085-05-B



POLISHED: DLC120-R0085-03
BLACK: DLC120-R0085-03-B



POLISHED: DLC120-R0085-00
BLACK: DLC120-R0085-00-B



POLISHED: DLC120-R0085-06
BLACK: DLC120-R0085-06-B



POLISHED: DLC120-R0085-BL
BLACK: DLC120-R0085-BL-B

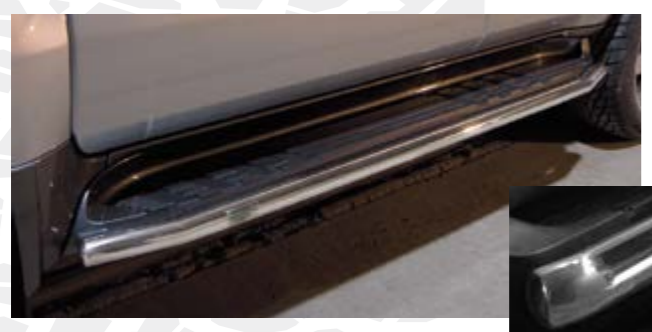

POLISHED: DLC120-R0048-R
BLACK: DLC120-R0048-R-B

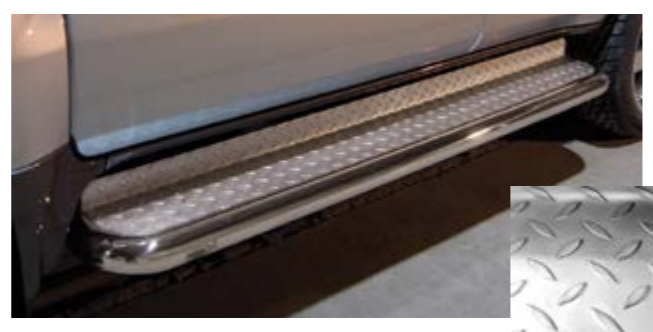

POLISHED: DLC120-R0085-PR
BLACK: DLC120-R0085-PR-B



POLISHED: DLC120-R0085-NR
BLACK: DLC120-R0085-NR-B



POLISHED: DLC120-R0085-NR-01
BLACK: DLC120-R0085-NR-01-B



POLISHED: DLC120-R0085-NR-02
BLACK: DLC120-R0085-NR-02-B

TOYOTA LAND CRUISER 150

2010-2013



POLISHED: DLC150-R0085-00
BLACK: DLC150-R0085-00-B



POLISHED: DLC150-R0076-04
BLACK: DLC150-R0076-04-B



POLISHED: DLC150-R0076-06
BLACK: DLC150-R0076-06-B



POLISHED: DLC150-R0085-03
BLACK: DLC150-R0085-03-B



POLISHED: DLC150-R0085-05
BLACK: DLC150-R0085-05-B



POLISHED: DLC150-R0085-06
BLACK: DLC150-R0085-06-B



POLISHED: DLC150-R0085-BL
BLACK: DLC150-R0085-BL-B



POLISHED: DLC150-R0048-R
BLACK: DLC150-R0048-R-B



POLISHED: DLC150-R0085-PR
BLACK: DLC150-R0085-PR-B



POLISHED: DLC150-R0085-NR
BLACK: DLC150-R0085-NR-B



POLISHED: DLC150-R0085-NR-01
BLACK: DLC150-R0085-NR-01-B

TOYOTA LAND CRUISER 150
2013-2017



POLISHED: DLC150-R1370-00
BLACK: DLC150-R1370-00-B



POLISHED: DLC150-L1370-03
BLACK: DLC150-R1370-03-B



POLISHED: DLC150-L1370-05
BLACK: DLC150-R1370-04-B



POLISHED: DLC150-L1370-05
BLACK: DLC150-L1370-05-B



POLISHED: DLC150-R1370-06
BLACK: DLC150-R1370-06-B



POLISHED: DLC150-L1370-07
BLACK: DLC150-L1370-07-B



POLISHED: DLC150-L1370-08
BLACK: DLC150-L1370-08-B



POLISHED: DLC150-R1348-R
BLACK: DLC150-R1348-R-B



POLISHED: DLC150-R1370-PR
BLACK: DLC150-R1370-PR-B



POLISHED: DLC150-R1370-NR
BLACK: DLC150-R1370-NR-B



POLISHED: DLC150-R1370-NR-01
BLACK: DLC150-R1370-NR-01-B

TOYOTA LAND CRUISER 150 - AT35



AT35 CONVERSION

The Toyota Land Cruiser 150 AT35 is based on the well known and worldwide established Toyota Land Cruiser. In order to fit the larger 315x70 R17 off-road tires the front and rear suspension is lifted 40 mm and the wheel arches are cut up and made larger. Tailor made fender flares are fitted to cover the large tires.

The LC150 modified with 35" tires gives you excellent performance off road but also provides you with an outstanding overview of the traffic in the city. Behind the wheel of this car you have the ability to decide where to go, whether if that is a ride in style in the city or a trip to the roughest outback.

AT35 CONTENTS

- 315x70 R17" tires BFG AT KO2 or Nokian Hakkapeliitta LT2 „Arctic Trucks”
- 17x10" Arctic Trucks alloy wheels
- Torque wrench
- Fender flares, painted
- Running board brackets
- Mud flaps
- Speedometer calibrator
- 40 mm suspension lift, front/rear
- Fender trimming, front/rear
- First aid kit
- Wheel alignment

AFTER CONVERSION

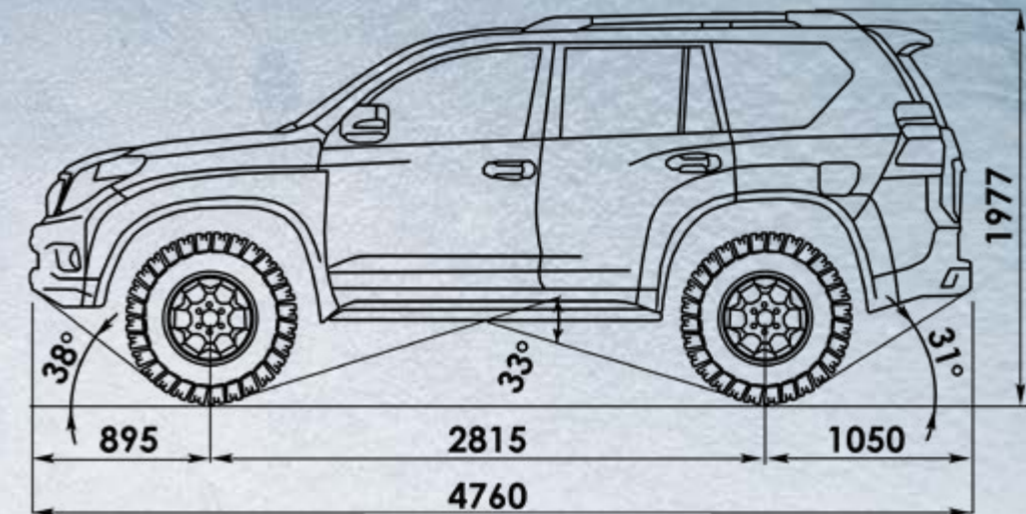

Choose your Suspension

Choose your tyres



OE suspension (stock)

OME BP-51 suspension



BF Goodrich A/T KO2 315/70 R17

Nokian Hakkapeliitta LT 2 315/70 R17

Modification cost with OE suspension: 10 650 euro net
Delivery to our location not included.
Lead time: 14 working days.

Contact:
e-mail: info@arctictrucks.pl
phone: +48 85 711 95 58

TOYOTA LAND CRUISER 150 2017-



POLISHED: DLC150-R1770-04
BLACK: DLC150-R1770-04 -B



POLISHED: DLC150-R1770-03
BLACK: DLC150-R1770-03-B



POLISHED: DLC150-R1770-06
BLACK: DLC150-R1770-06-B



POLISHED: DLC150-R1770-00
BLACK: DLC150-R1770-00 -B



POLISHED: DLC150-L1770-05
BLACK: DLC150-L1770-05-B



POLISHED: DLC150-L1770-07
BLACK: DLC150-L1770-07-B



POLISHED: DLC150-L1770-08
BLACK: DLC150-L1770-08-B



POLISHED: DLC150-R1748-R
BLACK: DLC150-R1748-R-B



POLISHED: DLC150-R1770-PR
BLACK: DLC150-R1770-PR-B



POLISHED: DLC150-R1770-NR
BLACK: DLC150-R1770-NR-B



POLISHED: DLC150-R1770-NR-01
BLACK: DLC150-R1770-NR-01-B

TOYOTA LAND CRUISER V8

R00-(2007-2012) / R12-(2012-2016)



POLISHED: DLCV8-R0085-BL / DLCV8-R1285-BL
BLACK: DLCV8-R0085-BL-B / DLCV8-R1285-BL-B



POLISHED: DLCV8-R0048-R / DLCV8-R1248-R
BLACK: DLCV8-R0048-R-B / DLCV8-R1248-R-B



POLISHED: DLCV8-R0076-PR / DLCV8-R1285-PR
BLACK: DLCV8-R0076-PR-B / DLCV8-R1285-PR-B



POLISHED: DLCV8-R0076-04 / DLCV8-R1276-04
BLACK: DLCV8-R0076-04-B / DLCV8-R1276-04-B



POLISHED: DLCV8-R0076-05 / DLCV8-R1276-05
BLACK: DLCV8-R0076-05-B / DLCV8-R1276-05-B



POLISHED: DLCV8-R0076-06 / DLCV8-R1276-06
BLACK: DLCV8-R0076-06-B / DLCV8-R1276-06-B



POLISHED: DLCV8-R0085-00 / DLCV8-R1285-00
BLACK: DLCV8-R0085-00-B / DLCV8-R1285-00-B



POLISHED: DLCV8-R0085-03 / DLCV8-R1285-03
BLACK: DLCV8-R0085-03-B / DLCV8-R1285-03-B



POLISHED: DLCV8-R0085-06 / DLCV8-R1285-06
BLACK: DLCV8-R0085-06-B / DLCV8-R1285-06-B



POLISHED: DLCV8-R0085-NR-02
BLACK: DLCV8-R0085-NR-02-B



POLISHED: DLCV8-R0085-NR / DLCV8-R1285-NR
BLACK: DLCV8-R0085-NR-B / DLCV8-R1285-NR-B



POLISHED: DLCV8-R0085-NR-01 / DLCV8-R1285-NR-01
BLACK: DLCV8-R0085-NR-01-B / DLCV8-R1285-NR-01-B

TOYOTA LAND CRUISER V8 / LC200 - AT35



AT35 CONVERSION

The LC V8 AT35 is the top of the line in the Arctic Trucks family. The Land Cruiser 200 is fitted with 35" tires and suspension lift. Tailor made fender flares are fitted that will give your car a prestigious yet powerful look. The perfect combination of power and grace.

The LC V8 modified with 35" tires gives you excellent performance off road but also provides you with an outstanding overview of the traffic in the city. Behind the wheel of this car you have the ability to decide where to go, whether if that is a ride in style in the city or a trip to the roughest outback.

This modification is the perfect choice for the urban professional who wants the best of two worlds, urban style and off road. You decide.

AT35 CONTENTS

- 315x70 R17" tires BFG AT KO2 or Nokian Hakkapeliitta LT2 „Arctic Trucks”
- Alloy wheels 17"x10"
- Side steps brackets
- Mud flaps
- Speedometer calibration unit
- Suspension lift
- Cut fenders, front/back
- First aid kit
- Wheel balance
- Torque wrench set

AFTER CONVERSION

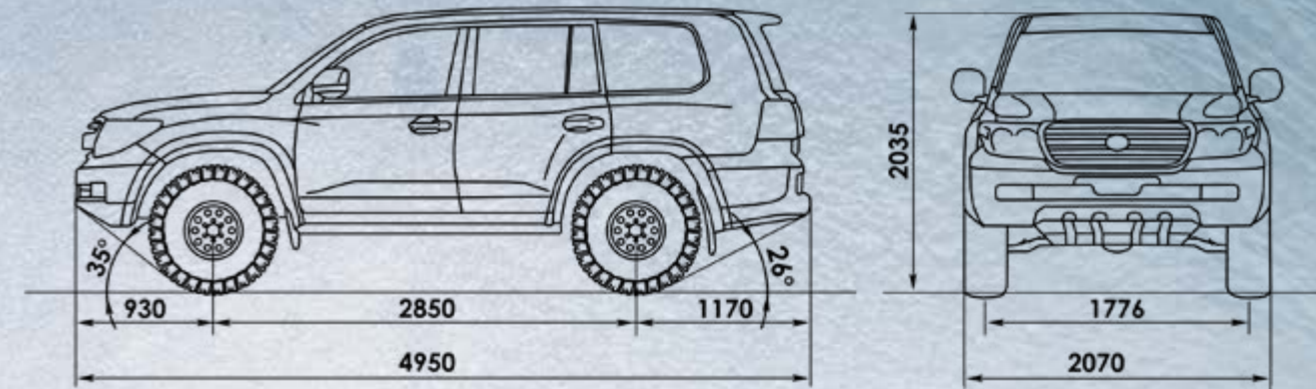

Choose your Suspension

Choose your tyres



OE suspension (stock)

OME BP-51 suspension



BF Goodrich A/T KO2 315/70 R17

Nokian Hakkapeliitta LT 2 315/70 R17

Modification cost with OE suspension: 9 500 euro net
Delivery to our location not included.
Lead time: 10 working days.

Contact:
e-mail: info@arctictrucks.pl
phone: +48 85 711 95 58



STEELER
ul. Grodzińska 206
16-100 Sokolka
Poland
NIP: 545-161-39-48
www.arctictrucks.pl

TOYOTA PROACE / PROACE VERSO
2016-

TOYOTA RAV4
2006-2010



POLISHED: PROACE-R1660-04 / PROACE-R1660-04-VERSO
BLACK: PROACE-R1660-04 -B / PROACE-R1660-04-VERSO-B

POLISHED: RAV4-R0076
BLACK: RAV4-R0076-B



POLISHED: PROACE-R1660-06 / PROACE-R1660-06-VERSO
BLACK: PROACE-R1660-06 -B / PROACE-R1660-06-VERSO-B

POLISHED: PROACE-R1648-R
BLACK: PROACE-R1648-R-B

POLISHED: RAV4-R0076-R
BLACK: RAV4-R0076-R-B

POLISHED: RAV4-R0076-PR
BLACK: RAV4-R0076-PR-B



POLISHED: PROACE-R1660-03 / PROACE-R1660-03-VERSO
BLACK: PROACE-R1660-03 -B / PROACE-R1660-03-VERSO-B

POLISHED: PROACE-L1660-05 / PROACE-L1660-05-VERSO
BLACK: PROACE-L1660-05 -B / PROACE-L1660-05-VERSO-B

POLISHED: RAV4-R0076-PR-01
BLACK: RAV4-R0076-PR-01-B

POLISHED: RAV4-R0076-PR-02
BLACK: RAV4-R0076-PR-02-B

TOYOTA RAV4
2006-2010



POLISHED: RAV4-R0076-06
BLACK: RAV4-R0076-06-B



POLISHED: RAV4-R0076-03
BLACK: RAV4-R0076-03-B



POLISHED: RAV4-R0076-BL
BLACK: RAV4-R0076-BL-B



POLISHED: RAV4-R0076-05
BLACK: RAV4-R0076-05-B



POLISHED: RAV4-R0076-04
BLACK: RAV4-R0076-04-B



POLISHED: RAV4-R0076-NR
BLACK: RAV4-R0076-NR-B



POLISHED: RAV4-R0076-NR-01
BLACK: RAV4-R0076-NR-01-B

TOYOTA RAV4
2010-2013



POLISHED: RAV4-R1076-00
BLACK: RAV4-R1076-00-B



POLISHED: RAV4-R1076-R
BLACK: RAV4-R1076-R-B



POLISHED: RAV4-R1076-PR
BLACK: RAV4-R1076-PR-B



POLISHED: RAV4-R1076-PR-01
BLACK: RAV4-R1076-PR-01-B



POLISHED: RAV4-R1076-PR-02
BLACK: RAV4-R1076-PR-02-B

TOYOTA RAV4

2010-2013



POLISHED: RAV4-R1076-03
BLACK: RAV4-R1076-03-B



POLISHED: RAV4-R1076-06
BLACK: RAV4-R1076-06-B



POLISHED: RAV4-R1076-BL
BLACK: RAV4-R1076-BL-B



POLISHED: RAV4-L1076-04
BLACK: RAV4-L1076-04-B



POLISHED: RAV4-L1076-05
BLACK: RAV4-L1076-05-B



POLISHED: RAV4-L1076-07
BLACK: RAV4-L1076-07-B



POLISHED: RAV4-R1076-NR
BLACK: RAV4-R1076-NR-B

POLISHED: RAV4-R1076-NR-01
BLACK: RAV4-R1076-NR-01-B

TOYOTA RAV4

2013-2015



POLISHED: RAV4-R1370
BLACK: RAV4-R1370-B



POLISHED: RAV4-R1370-R
BLACK: RAV4-R1370-R-B



POLISHED: RAV4-R1370-PR
BLACK: RAV4-R1370-PR-B



POLISHED: RAV4-R1376-PR-01
BLACK: RAV4-R1376-PR-01-B



POLISHED: RAV4-R1370-PR-02
BLACK: RAV4-R1370-PR-02-B

TOYOTA RAV4
2013-2015



POLISHED: RAV4-R1370-03
BLACK: RAV4-R1370-03-B



POLISHED: RAV4-R1370-04
BLACK: RAV4-R1370-04-B



POLISHED: RAV4-R1370-06
BLACK: RAV4-R1370-06-B



POLISHED: RAV4-R1376-04
BLACK: RAV4-R1376-04-B



POLISHED: RAV4-R1376-05
BLACK: RAV4-R1376-05-B



POLISHED: RAV4-R1376-07
BLACK: RAV4-R1376-07-B

POLISHED: RAV4-R1370-NR
BLACK: RAV4-R1370-NR-B



TOYOTA RAV4
2015-



POLISHED: RAV4-R1670-00
BLACK: RAV4-R1670-00-B



POLISHED: RAV4-R1670-NR
BLACK: RAV4-R1670-NR-B



POLISHED: RAV4-R1670-R
BLACK: RAV4-R1670-R-B

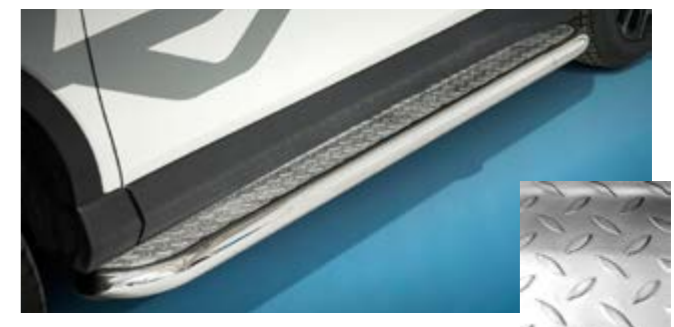

POLISHED: RAV4-R1670-PR
BLACK: RAV4-R1670-PR-B

TOYOTA RAV4

2015-



POLISHED: RAV4-R1670-04
BLACK: RAV4-R1670-04-B



POLISHED: RAV4-R1670-03
BLACK: RAV4-R1670-03-B



POLISHED: RAV4-R1670-06
BLACK: RAV4-R1670-06-B



POLISHED: RAV4-L1670-05
BLACK: RAV4-L1670-05-B



POLISHED: RAV4-L1670-08
BLACK: RAV4-L1670-08-B



POLISHED: RAV4-L1670-07
BLACK: RAV4-L1670-07-B



POLISHED: RAV4-R1680-PR-04
BLACK: RAV4-R1680-PR-04-B



POLISHED: RAV4-R1676-PR-01
BLACK: RAV4-R1676-PR-01-B

VOLKSWAGEN AMAROK

2009-2016



POLISHED: AMAROK-R0070
BLACK: AMAROK-R0070-B

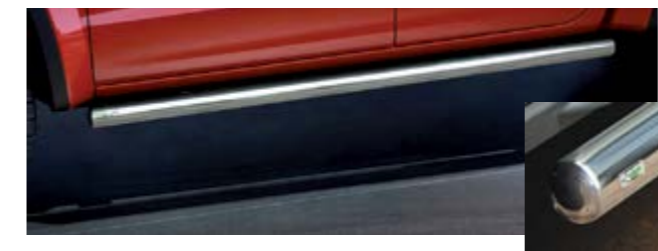

POLISHED: AMAROK-R0070-R
BLACK: AMAROK-R0070-R-B

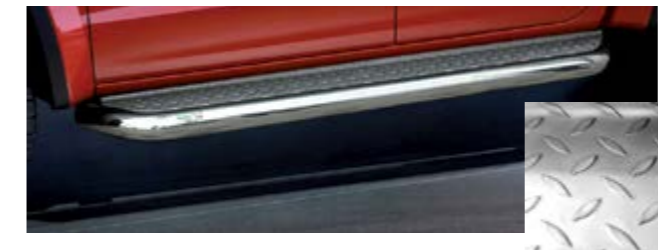

POLISHED: AMAROK-R0070-PR
BLACK: AMAROK-R0070-PR-B

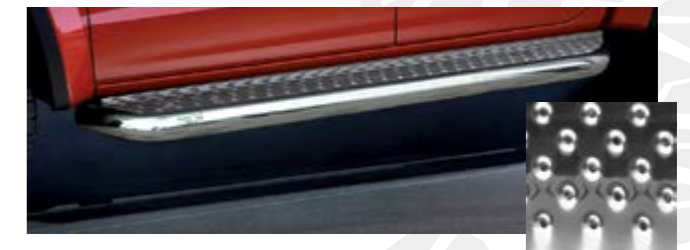

POLISHED: AMAROK-R0070-PR-03
BLACK: AMAROK-R0070-PR-03-B

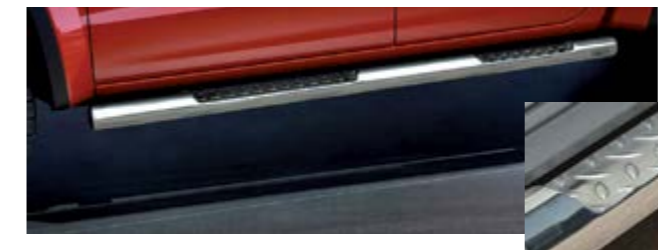

POLISHED: AMAROK-R0076-PR-01
BLACK: AMAROK-R0076-PR-01-B



POLISHED: AMAROK-R0070-PR-02
BLACK: AMAROK-R0070-PR-02-B

VOLKSWAGEN AMAROK

2009-2016



POLISHED: AMAROK-R0070-03
BLACK: AMAROK-R0070-03-B



POLISHED: AMAROK-R0070-04
BLACK: AMAROK-R0070-04-B



POLISHED: AMAROK-R0070-06
BLACK: AMAROK-R0070-06-B



POLISHED: AMAROK-R0076-03 / AMAROK-R0076-03-SKID
BLACK: AMAROK-R0076-03-B / AMAROK-R0076-03-SKID-B



POLISHED: AMAROK-R0076-04 / AMAROK-R0076-04-SKID
BLACK: AMAROK-R0076-04-B / AMAROK-R0076-04-SKID-B



POLISHED: AMAROK-R0076-06 / AMAROK-R0076-06-SKID
BLACK: AMAROK-R0076-06-B / AMAROK-R0076-06-SKID-B



POLISHED: AMAROK-R0076-GR
BLACK: AMAROK-R0076-GR-B



POLISHED: AMAROK-R0076-2GR
BLACK: AMAROK-R0076-2GR-B

VOLKSWAGEN AMAROK V6

2016-



POLISHED: AMAROK-R1670-00

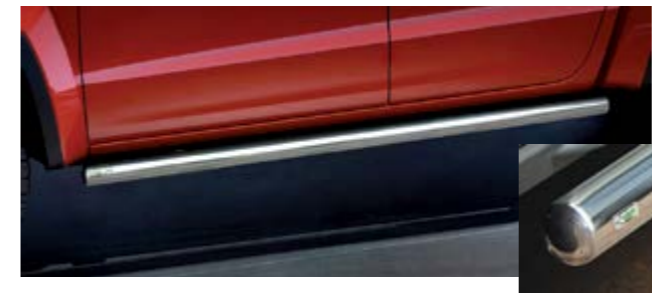

POLISHED: AMAROK-R0070-R

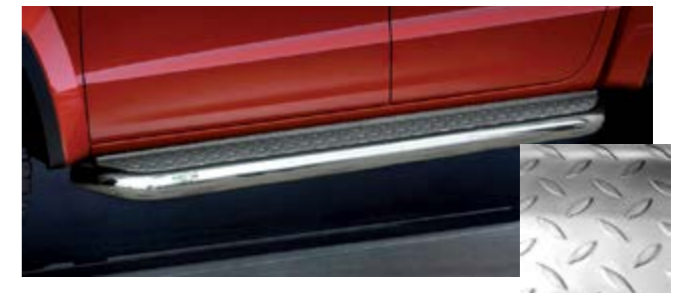

POLISHED: AMAROK-R0070-PR

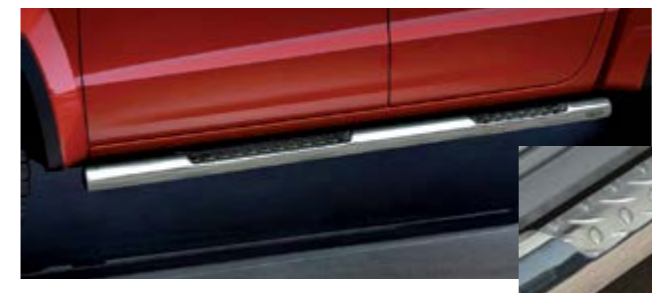

POLISHED: AMAROK-R0076-PR-01

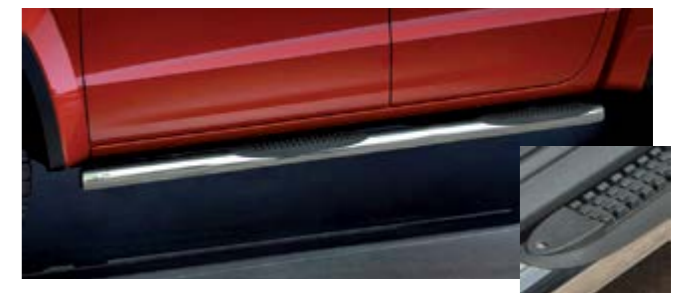

POLISHED: AMAROK-R0070-PR-02

VOLKSWAGEN AMAROK V6 2016-



POLISHED: AMAROK-R1670-06



POLISHED: AMAROK-R1670-03



BLACK: AMAROK-R1670-06-B



BLACK: AMAROK-L1670-05-B



POLISHED: AMAROK-L1670-05



POLISHED: AMAROK-L1670-07



BLACK: AMAROK-R1670-03-B



BLACK: AMAROK-L1670-07-B



POLISHED: AMAROK-R1670-04



POLISHED: AMAROK-L1670-08



BLACK: AMAROK-R1670-04-B



BLACK: AMAROK-L1670-08-B



BLACK: AMAROK-R1670-00-B

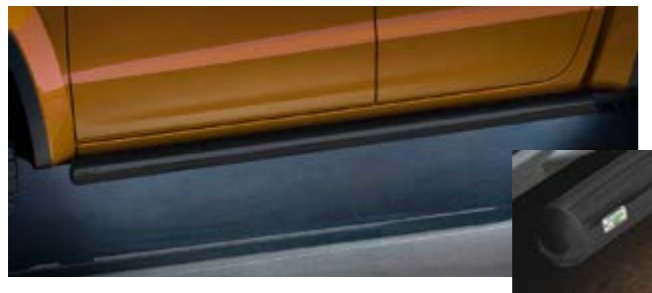

BLACK: AMAROK-R0070-R-B

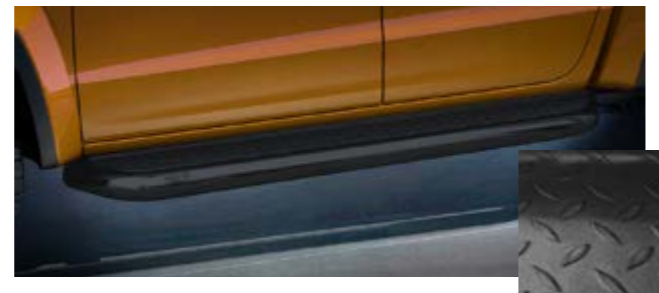

BLACK: AMAROK-R0070-PR-B

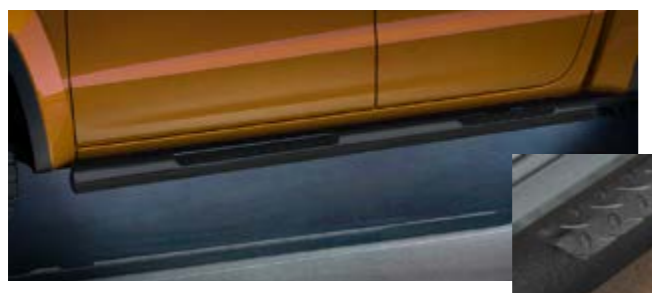

BLACK: AMAROK-R0076-PR-01-B



BLACK: AMAROK-R0070-PR-02-B



POLISHED: AMAROK-R0076-GR
BLACK: AMAROK-R0076-GR-B



POLISHED: AMAROK-R0076-2GR
BLACK: AMAROK-R0076-2GR-B

VOLKSWAGEN CADDY
2010-2017

POLISHED: CADDY-R1070
BLACK: CADDY-R1070-B



POLISHED: CADDY-R1070-03
BLACK: CADDY-R1070-03-B



POLISHED: CADDY-R1060-R / CADDY-R1060-R-MAXI
BLACK: CADDY-R1060-R-B / CADDY-R1060-R-MAXI-B



POLISHED: CADDY-R1070-04
BLACK: CADDY-R1070-04-B



POLISHED: CADDY-R1076-06
BLACK: CADDY-R1076-06-B

VOLKSWAGEN CRAFTER
2006-2017



POLISHED: CRAFTER-R0070
BLACK: CRAFTER-R0070-B



POLISHED: CRAFTER-R0070-03
BLACK: CRAFTER-R0070-03-B



POLISHED: CRAFTER-R0070-04
BLACK: CRAFTER-R0070-04-B

VOLKSWAGEN CRAFTER

2017-



POLISHED: CRAF-L1770-08
BLACK: CRAF-L1770-08-B



POLISHED: CRAF-L1770-05
BLACK: CRAF-L1770-05-B



POLISHED: CRAF-R1770-06
BLACK: CRAF-R1770-06-B



POLISHED: CRAF-R1770-03
BLACK: CRAF-R1770-03-B



POLISHED: CRAF-R1770-00
BLACK: CRAF-R1770-00-B



POLISHED: CRAF-R1770-04
BLACK: CRAF-R1770-04-B



POLISHED: CRAF-R1760-R-SWB
BLACK: CRAF-R1760-R-SWB-B



POLISHED: CRAF-R1770-PR-02-SWB
BLACK: CRAF-R1770-PR-02-SWB-B



POLISHED: CRAF-R1776-PR-01-SWB
BLACK: CRAF-R1776-PR-01-SWB-B

VOLKSWAGEN T5
2003-2010-2015



POLISHED: T5-R0070-04
BLACK: T5-R0070-04-B



POLISHED: T5-R0070
BLACK: T5-R0070-B



POLISHED: T5-R0070-03
BLACK: T5-R0070-03-B



POLISHED: T5-R0070-06
BLACK: T5-R0070-06-B



POLISHED: T5-R0076-04
BLACK: T5-R0076-04-B



POLISHED: T5-R0076-06
BLACK: T5-R0076-06-B



POLISHED: T5-R0060-R-SWB / T5-R0060-R-LWB
BLACK: T5-R0060-R-SWB-B / T5-R0060-R-LWB-B



POLISHED: T5-R0070-PR-SWB / T5-R0070-PR-LWB
BLACK: T5-R0070-PR-SWB-B / T5-R0070-PR-LWB-B



POLISHED: T5-R0076-PR-01-SWB / T5-R0076-PR-01-LWB
BLACK: T5-R0076-PR-01-SWB-B / T5-R0076-PR-01-LWB-B



POLISHED: T5-R0070-PR-02-SWB-B / T5-R0070-PR-02-LWB-B
BLACK: T5-R0070-PR-02-SWB / T5-R0070-PR-02-LWB

VOLKSWAGEN T6 2015-



POLISHED: T6-L1570-08
BLACK: T6-L1570-08-B



POLISHED: T6-L1570-05
BLACK: T6-L1570-05-B



POLISHED: T6-R1570-03
BLACK: T6-R1570-03-B



POLISHED: T6-R1570-06
BLACK: T6-R1570-06-B



POLISHED: T6-R1570-00
BLACK: T6-R1570-00-B



POLISHED: T6-R1570-04
BLACK: T6-R1570-04 -B



POLISHED: T6-R1560-R-SWB
BLACK: T6-R1560-R-SWB-B



POLISHED: T6-R1570-PR-02-SWB/LWB
BLACK: T6-R1570-PR-02-SWB-B/LWB-B



POLISHED: T6-R1576-PR-01-SWB-B/LWB-B
BLACK: T6-R1576-PR-01-SWB-B/LWB-B

VOLKSWAGEN TIGUAN

2007-2011-2015



POLISHED: TIGUAN-R0070-00
BLACK: TIGUAN-R0070-00-B



POLISHED: TIGUAN-R0070-04
BLACK: TIGUAN-R0070-04-B



POLISHED: TIGUAN-R0070-03
BLACK: TIGUAN-R0070-03-B



POLISHED: TIGUAN-R0076-04
BLACK: TIGUAN-R0076-04-B



POLISHED: TIGUAN-R0070-06
BLACK: TIGUAN-R0070-06-B



POLISHED: TIGUAN-R0076-06
BLACK: TIGUAN-R0076-06-B



POLISHED: TIGUAN-R0060-R
BLACK: TIGUAN-R0060-R-B



POLISHED: TIGUAN-R0070-PR
BLACK: TIGUAN-R0070-PR-B



POLISHED: TIGUAN-R0076-PR-01
BLACK: TIGUAN-R0076-PR-01-B



POLISHED: TIGUAN-R0070-PR-02
BLACK: TIGUAN-R0070-PR-02-B

POLISHED: TIGUAN-R0076-NR
BLACK: TIGUAN-R0076-NR-B



VOLKSWAGEN TOUREG

2011-2015



POLISHED: TOUAREG-R1170
BLACK: TOUAREG-R1170-B



POLISHED: TOUAREG-R1170-03
BLACK: TOUAREG-R1170-03-B



POLISHED: TOUAREG-R1170-04
BLACK: TOUAREG-R1170-04-B



POLISHED: TOUAREG-R1170-06
BLACK: TOUAREG-R1170-06-B



POLISHED: TOUAREG-R1176-04
BLACK: TOUAREG-R1176-04-B



POLISHED: TOUAREG-R1176-06
BLACK: TOUAREG-R1176-06-B



POLISHED: TOUAREG-R1176-PR-01
BLACK: TOUAREG-R1176-PR-01-B



POLISHED: TOUAREG-R1170-PR-02
BLACK: TOUAREG-R1170-PR-02-B



POLISHED: TOUAREG-R1176-R
BLACK: TOUAREG-R1176-R-B

VOLVO XC60
2014-2017



POLISHED: XC60-N1460-10
BLACK: XC60-N1460-10-B



POLISHED: XC60-N1460-09
BLACK: XC60-N1460-09-B



POLISHED: XC60-L1460-05
BLACK: XC60-L1460-05-B



POLISHED: XC60-R1460-06
BLACK: XC60-R1460-06-B



POLISHED: XC60-L1460-08
BLACK: XC60-L1460-08-B



POLISHED: XC60-R1460-03
BLACK: XC60-R1460-03-B



POLISHED: XC60-R1460-04
BLACK: XC60-R1460-04-B



POLISHED: XC60-R1460-00
BLACK: XC60-R1460-00-B



POLISHED: XC60-R1460-R
BLACK: XC60-R1460-R-B



POLISHED: XC60-R1476-PR-01
BLACK: XC60-R1476-PR-01-B



POLISHED: XC60-R1470-PR-02
BLACK: XC60-R1470-PR-02-B

4X4 & PICK-UP ACCESSORIES

ALL STAINLESS STEEL BARS
ALSO AVAILABLE IN **BLACK**



Mountain Top roll-covers



Mountain Top aluminium cover



Over & under rail bedliners



Tonneau covers



Aeroklas canopies



Alpha SCZ canopies

Hardtops
and tonneau covers for:

- Fiat Fullback
- Ford Ranger
- Isuzu D-MAX
- Mitsubishi L200
- Nissan Navara
- Nissan NP300
- Toyota Hilux
- Volkswagen Amarok
- X-Class



TYPE E Series



CHECK OUR QUALITY IN **DETAILS**

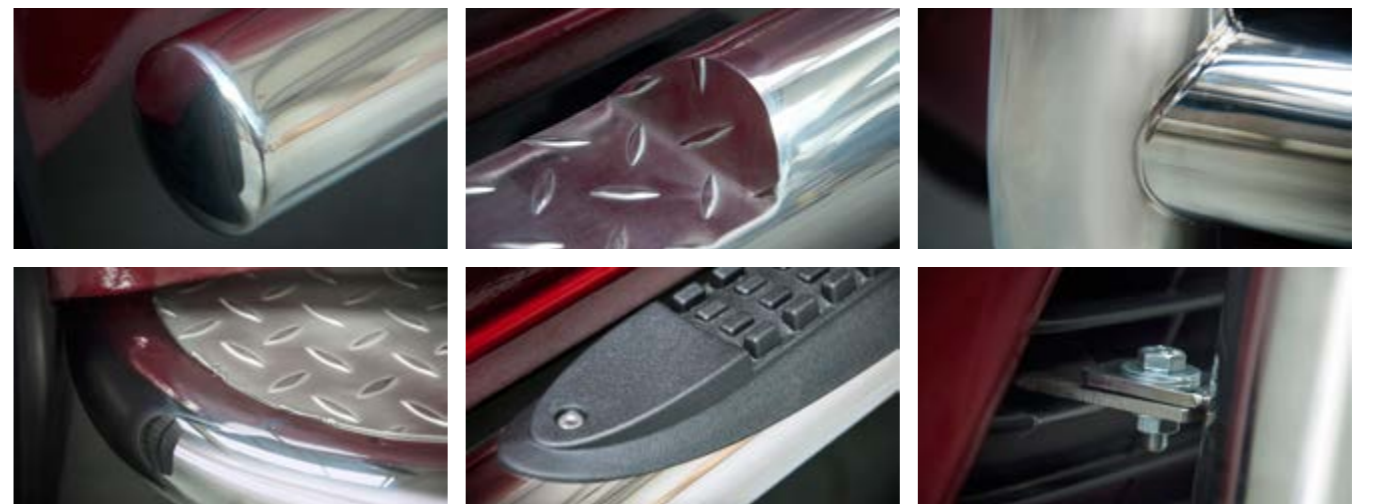

UPGRADE YOUR BARS WITH HELLA & LAZER LIGHTS



UTILITY HARDTOPS FOR PROFESSIONALS



UTILITY HARDTOPS FOR PROFESSIONALS

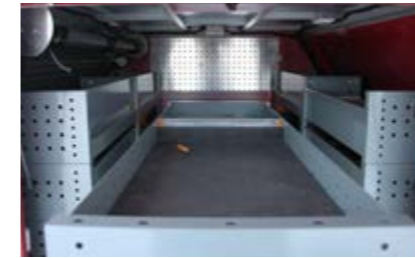



STEELER
ul. Grodzińska 206
16-100 Sokolka
Poland
info@steeler.pl
website: www.steeler.pl
e-shop: www.steeler4x4.com
tel.: 85 711 95 58
fax: 85 711 95 59

STEELEER® 2018 www.steelers.com • www.steelers4x4.com